



Novatek-Electro EM-486 Documentation

<https://www.overvis.com/docs/pl/em-486/>

2026-03-30

Table of Contents

1. Novatek-Electro EM-486
2. EM-486 Operating Manual
3. Appendix A: Versions and Modifications
4. Appendix B: Connections
5. Appendix C: Task Files
6. Appendix D: Modbus Registers
7. Appendix E: Saving Data to Memory Card
8. Appendix F: Web Interfaces
9. Appendix G: Updating Firmware
10. Task File Examples
11. Relay Control Based on OM-310 Fault
12. Hysteresis Control for TR-101
13. Temperature Alarm with SMS
14. Simple Timer-Based Relay Control
15. Simple Temperature Control
16. Astronomical Timer / Light Sensor

Novatek-Electro EM-486

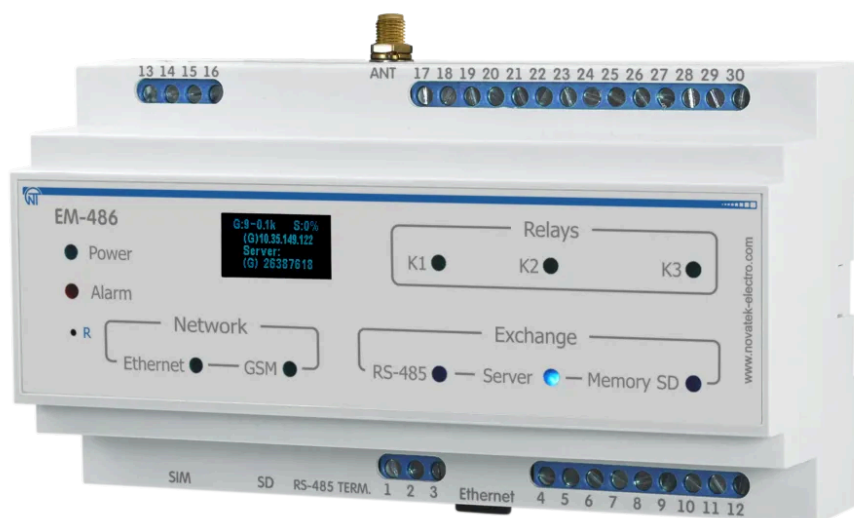

EM-486 to konwerter protokołów MODBUS RTU/ASCII (RS-485) produkowany przez NOVATEK-ELECTRO LTD. Zapewnia zbieranie danych, przesyłanie na serwer, dostęp przez MODBUS TCP lub SMS, śledzenie zdarzeń i reakcje.

 **Dostępna pełna dokumentacja**

Wyświetl całą dokumentację na jednej stronie – Idealna do drukowania lub czytania offline

Kluczowe cechy

- Elastyczne opcje połączenia (Ethernet, GSM/GPRS, automatyczny wybór)
- Programowanie zbierania danych, zdarzeń i akcji przez pliki zadań
- Programowalne wyjścia przekaźnikowe (K1, K2, K3)
- Obsługa karty SD do rejestrowania danych
- Graficzny wyświetlacz OLED

Dokumentacja

- **Instrukcja obsługi**

Dokumentacja techniczna

- **Dodatek A: Wersje i modyfikacje**
- **Dodatek B: Schematy połączeń**
- **Dodatek C: Pliki zadań**
- **Dodatek D: Rejestry MODBUS**

- **Dodatek E: Karta pamięci**
- **Dodatek F: Interfejsy WWW**
- **Dodatek G: Aktualizacja firmware**

Przykłady

- **Przykłady zadań**

Zasoby dodatkowe

- Strona produktu EM-486 – Pełne informacje o produkcie i specyfikacje
- Dokumentacja jednostronicowa – Kompletna dokumentacja na jednej stronie do drukowania
- Pełna instrukcja EM-486 (PDF) – Kompletna instrukcja obsługi

Wsparcie

- **Centrum wsparcia:** Odwiedź nasze Centrum wsparcia
- **Zgłoś problem:** Wyślij zgłoszenie

EM-486 Operating Manual

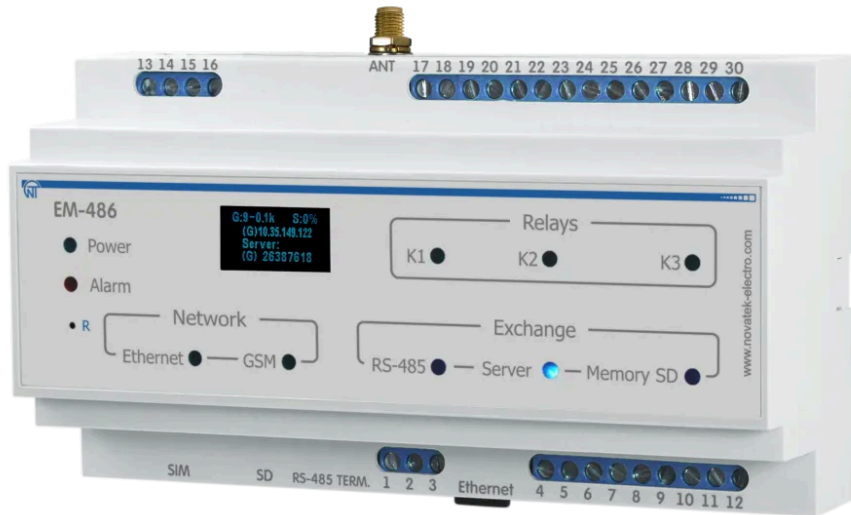

The EM-486 is a MODBUS RTU/ASCII (RS-485) protocol converter manufactured by NOVATEK-ELECTRO LTD.

Dear Customer

Company NOVATEK-ELECTRO LTD thanks you for purchasing our device. You will be able to use properly the device after carefully studying the Operating Manual. Keep the Operating Manual throughout the service life of the device.

ATTENTION

ALL REQUIREMENTS OF THIS OPERATING MANUAL ARE COMPULSORY TO BE MET!

WARNING! DEVICE TERMINALS AND INTERNAL COMPONENTS ARE UNDER POTENTIALLY LETHAL VOLTAGE.

TO ENSURE THE DEVICE SAFE OPERATION **IT IS STRICTLY FORBIDDEN THE FOLLOWING:**

- TO CARRY OUT MOUNTING WORKS AND MAINTENANCE **WITHOUT DISCONNECTING THE DEVICE FROM THE MAINS;**
- TO OPEN AND REPAIR THE DEVICE INDEPENDENTLY;
- TO OPERATE THE DEVICE WITH MECHANICAL DAMAGES OF THE CASE.

IT IS NOT ALLOWED WATER PENETRATION ON TERMINALS AND INTERNAL ELEMENTS OF THE DEVICE.

During operation and maintenance, the regulatory document requirements must be met, namely: Regulations for Operation of Consumer Electrical Installations; Safety Rules for Operation of Consumer Electrical Installations; Occupational Safety when in Operation of Electrical Installations.

Installation, adjustment and maintenance of the device must be performed by qualified personnel having studied this Operating Manual.

In compliance with the requirements of this Operating Manual and regulations the device is safe for use.

This Operating Manual is intended to familiarize you with the device, the requirements for safety, operation and maintenance procedures of the MODBUS RTU/ASCII (RS-485) protocol converter EM-486 (hereinafter referred to as EM-486, device).

The device meets the requirements: EN 60947-1; EN 60947-6-2; EN 55011; EN 61000-4-2.

Harmful substances in amounts exceeding maximum permissible concentrations are not available.

Versions of this device are listed in Appendix A - Versions and Modifications.

Terms and Abbreviations

- **10Base-T** – Ethernet standard for twisted pair communication with the speed of 10Mbit/s
- **100Base-T** – Ethernet standard for twisted pair communication with the speed of 100Mbit/s
- **8P8C/RJ45** – unified socket for 10Base-T/100Base-T network connections
- **ASCII** – table of standard codes for information interchange
- **Client** – device which is addressing the other devices (server) with a request to perform certain functions
- **Display** – OLED graphical indicator
- **DHCP** – Protocol that allows network nodes automatically obtaining the parameters of TCP/IP (IP address)
- **Ethernet** – standard for packet network communication and transmitting data between units (e.g., PCs)
- **FTP** – FTP protocol of a file transfer according to the standard TCP/IP
- **GPRS** – technology of packet transmission of data on mobile communication
- **GSM** – standard of digital mobile communication
- **HTTP** – protocol for transferring Web-pages and other data over “client-server” technology
- **Indicator** – LED element
- **Internet** – global routing system of units for storing and transferring data
- **IP (protocol)** – routable protocol for transferring data over Ethernet. Part of TCP/IP and used for Internet
- **IP (address)** – node address which is unique within a single network, operating over the IP protocol
- **IPv4** – four bytes IP-address
- **MAC (address)** – address used for device authentication during Ethernet transmissions. Usually unique although qualified personnel can change it under certain circumstances
- **MAC-48** – six bytes MAC-address
- **MODBUS** – standard and protocol for packet communication over the “client-server” technology for industrial electronic units
- **MODBUS RTU** – communication protocol of the unit for byte wise transfer of the package
- **MODBUS ASCII** – communication protocol of the unit for the transfer of package in the form of ASCII-symbols
- **MODBUS TCP** – protocol for transferring MODBUS packages under the TCP/IP standard
- **NTP** – Protocol for clock synchronization at the network nodes with variable delays of transmission
- **Package** – block of data to be transmitted between devices
- **RS-485/EIA-485** – network standard for communicating units over the twisted pair

- **Server** – unit which performs specific functions at the request of other units
- **SMS** – standard and technology of transmitting the brief messages via mobile communication
- **TCP/IP** – standard and a set of protocols for transferring data along the networks with delivery verification
- **Twisted pair** – pair of insulated conductors inside the cable, which are twisted together in order to reduce the distortion of the transmitted signal
- **WEB** – system for accessing documents on the server, used in the Internet
- **WEB-page** – document, file, resource, which is available on the Web-server
- **WEB-browser** – WEB-server client for accessing the WEB-pages, which is primarily using the HTTP protocol

1 Purpose

1.1 Purpose of the Device

EM-486 provides data collection from connected devices (analog sensors and MODBUS devices), data transfer to the server, access to data (via MODBUS TCP protocol or SMS text messages), event tracking and response (relay control, SMS sending - notifications, writing values to MODBUS devices, saving read values to the log).

EM-486 has:

- **Flexible options of connection** (via wire or wireless communication, automatic method selection of communicating with a server, automatic or manual selection of GSM provider and communication parameters, resetting of MAC-address and other Ethernet settings)
- **Access protection** (passwords for configuration or for connection to the MODBUS network, connection only to a specified server with automatic authorization, SMS control password)
- **Different modes of data interchange via RS-485** (RTU or ASCII, with checking of parity for even-odds or without checking, wide range of transmitting rate, adjustable delay)
- **Programming** the collection of data, events, and action for events (see Appendix C - Task Files)
- **Programmable outputs** for reaction at events and alarms
- **Programmable inputs** for analog sensors
- **Programmable impulse meters** for every sensor
- **Power output for sensors**
- **Reserve power supply input**
- **Service functions** (real time clock, firmware updating option)

1.2 Overall and Setting Dimensions

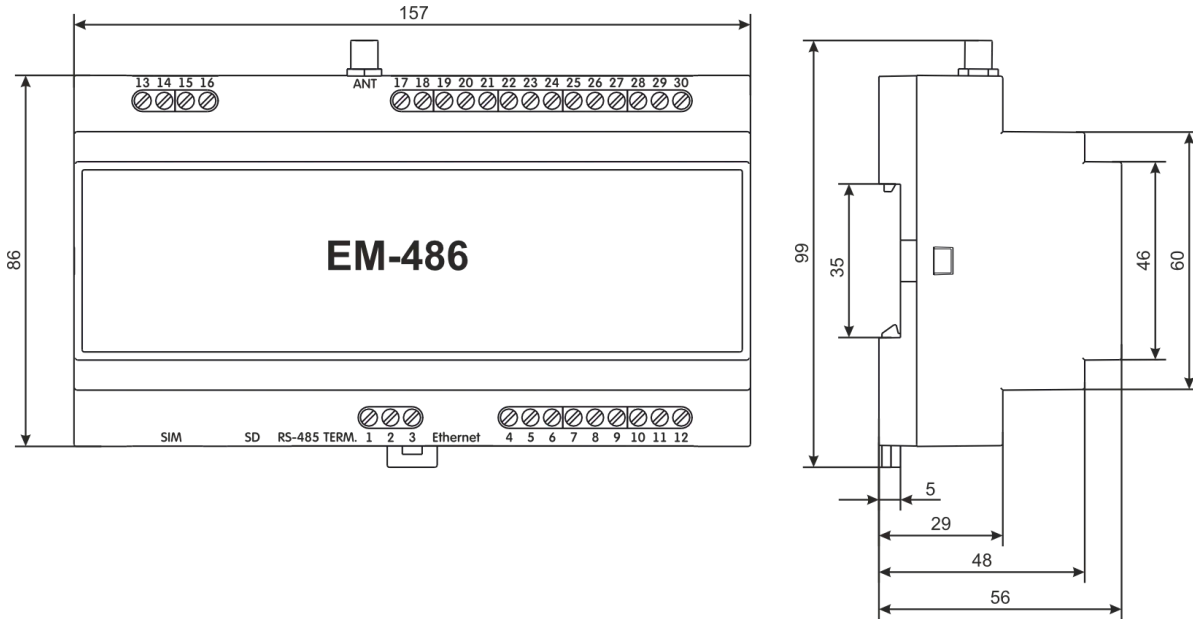

Figure 1.1 – Overall dimensions of the device

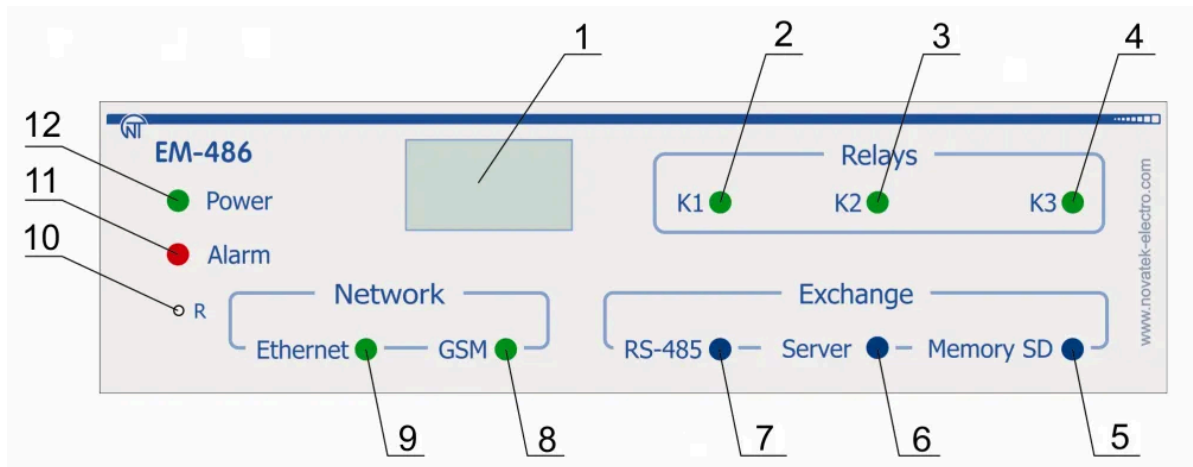

Figure 1.2 – Front panel of EM-486

1. **Graphic display OLED** is designed for indicating the state of the device, connections, communication interface loading and showing the alarm messages.
2. **Indicator «K1»** is lit on when relay K1 is activated.
3. **Indicator «K2»** is lit on when relay K2 is activated.
4. **Indicator «K3»** is lit on when relay K3 is activated.
5. **Indicator «Memory SD»** is lit on when there is a memory card in a special slot, is blinking while transmitting the data to the SD-card.
6. **Indicator «Server»** is lit on when there is a connection with a server for data accumulating, is blinking while data exchange with a server.
7. **Indicator «RS-485»** is lit on when waiting a respond from a device in MODBUS network; is blinking while data exchange via MODBUS network.

8. **Indicator «GSM»** is blinking every 3 seconds when there is a connection via GSM network, is blinking 3 times per second while data exchange via GPRS.
9. **Indicator «Ethernet»** is lit on when there is a connection via Ethernet network; it is blinking while data exchange via network.
10. **Reset button «R»** (is located under the casing and is available for pressing with a help of thin non-conductive object) is designed to restart the device or make factory reset.
11. **Alarm indicator «Alarm»** warns about a recording of the fault when analyzing of the received data.
12. **LED Indicator «Power»** is lit on when power voltage present.

1.3 Operating Conditions

EM-486 is designed for operation in the following conditions:

- Ambient temperature: from minus 35 to +55°C
- Atmospheric pressure: from 84 to 106.7 kPa
- Relative air humidity (at temperature of +25°C) 30 ... 80%

If the temperature of the device after transportation or storage is different from the temperature of the environment in which its operation is assumed, then before connecting to the mains keep the device in operation conditions for two hours (because on the device elements condensation may be available).

ATTENTION

The device is not intended for use:

- in conditions of significant vibration and shocks;
- in high humidity conditions;
- in corrosion environments with content in the air of acids, alkalis, etc., as well as severe contamination (grease, oil, dust, etc.).

2 Complete Supply Set

Item	Quantity
EM-486	1 pcs.
Cable for Ethernet connection	1 pcs.
GSM antenna (SMA M connector, 50 Ω)*	1 pcs.
MicroSD card (2 Gb)	1 pcs.
Operating Manual	1 pcs.
Shipping box	1 pcs.

* other types of antennas are delivered in coordination with the buyer

3 Technical Specifications

Parameter	Value
Operating supply voltage, VAC	230/240
Supply line frequency, Hz	45 – 65
Data Exchange Interface over the Ethernet network	10Base-T / 100Base-T
Supported Ethernet protocols	UDP, ARP, TCP
Data Exchange Interface over wireless network	GSM (850/900/1800/1900)
Supported standards of wireless network	SMS, GPRS
Integrated servers	MODBUS TCP, HTTP
Maximum number of connections over the MODBUS TCP protocol	4
Data Exchange Interface over the MODBUS network	RS-485
Supported protocols of MODBUS network	MODBUS RTU, MODBUS ASCII
Maximal output voltage of driver RS-485, V	3.3
Short circuit output voltage of driver RS-485 (maximal), mA	250
Resistance of inbuilt terminator, Ω	70 – 1000 or deactivated
The recommended number of connected devices in MODBUS network:	
- at input voltage of receivers on bus RS-485 not more than 0.125 mA	≤ 256
- at input voltage of receivers on bus RS-485 not more than 1 mA	≤ 32
Readiness time at power switching on, sec	$\leq 15^*$
Precision measurements of voltage, mV	≤ 100
Precision measurements of current, μA	≤ 200
Precision measurements of temperature, $^{\circ}\text{C}$	≤ 2
Rated voltage direct current back supply, V	12

Parameter	Value
Voltage supply at which operability is maintained:	
- alternative current, V	90 – 265
- direct current, V	127 – 375
Back supply voltage at which operability is maintained, V	9 – 16
Power consumption (under pressure), W	≤ 12
The maximum switched current of output pins, A	16
Universal inputs	4
Types of the connected gauges:	gauge with voltage output to 10 V; gauge with current output to 20 mA; «dry contact»; NTC temperature gauge
The maximum voltage on the universal input, V	12
The maximum current through the universal input, mA	24
The voltage of sensors power output, V	12
The maximum current of sensors power output, A	0.1
Programmable relay outputs with switching contacts, pcs.	3
Commutation service life of output contacts:	
- electrical service life under load 16 A (cos φ = 1.0), times	≥ 50,000
- mechanical service life, times	≥ 10,000,000
Device purpose	Communication equipment
Nominal operation condition	Continuous
The protection level	IP 20
Climatic version	NF 3.1
Permissible pollution density	II

Parameter	Value
Overvoltage category	II
Protection class against electrical shock	II
Rated insulation voltage, V	450
Rated impulse withstand voltage, kV	2.5
Cross section of wires of connection terminals, mm ²	0.5 – 3
Maximal tightening torque of terminals external screws, N·m	0.4
Weight, kg	≤ 0.750
Overall dimensions, H×B×L, mm	157 × 99 × 56
Standard 35 mm DIN rail mounting	
Housing material	Self-extinguishing plastic

* Connections on the Ethernet networks/Internet can take more time

The device remains operational capability in any position in space.

4 Design

EM-486 provides control for MODBUS in RS-485 network via Ethernet interfaces or GPRS, or via the SMS. The device also allows to read data from devices by MODBUS or from connected sensors.

The processor supports connection to the accumulating data cloud server via Ethernet network with a help of microchip of physical interface of Ethernet (or via GPRS with a help of inbuilt GSM-modem, if connection via Ethernet is not available). In addition, EM-486 can be connected via MODBUS TCP Protocol to exchange data with MODBUS devices, or with the device. The controller receives and processes SMS with a password and command read/write for MODBUS devices.

When inserting a memory card, the device reads the internal memory for operational logic – program for data collection and tracking of events. The program runs in the background mode. The collected data can be saved to a memory card in tabular or binary files.

The device stores in the built-in memory network settings, input and output parameters, security parameters, and action logic.

5 The Intended Use

5.1 Preparation for Operation

5.1.1 Preparation for Connection

- Unpack and check the device for damage after transportation; in case of such damages detection, contact the supplier or manufacturer;
- Carefully study the Operating Manual (pay special attention to the connection diagram to power the device);
- If you have any questions regarding the installation of the device, please contact the manufacturer by telephone number indicated at the end of this Operating Manual.

5.1.2 General Instructions

ATTENTION

The device is NOT DESIGNED FOR LOAD COMMUTATION IN CASE OF SHORT CIRCUITS. THEREFORE, THEY SHOULD BE PROTECTED BY AUTOMATIC CIRCUIT BREAKERS (FUSES) WITH TRIPPING CURRENT NOT EXCEEDING 16 A.

ALL CONNECTIONS MUST BE PERFORMED WHEN THE DEVICE IS DE-ENERGIZED.

Error when performing the installation works may damage the device and connected devices.

To ensure the reliability of electrical connections you should use flexible (stranded) wires with insulation for voltage of not less than 450 V, the ends of which it is necessary to be stripped of insulation for 5 ± 0.5 mm and tightened with bootlaces. Recommended cable cross section for connection is not less 1 mm².

EM-486 connection to RS-485 bus is made by cable of twisted pair type Cat.1 or higher category. It is recommended to use the shielded cable, in this case it should be grounded (in accordance with «ANSI/TIA/EIA-485-A-1998» recommendations).

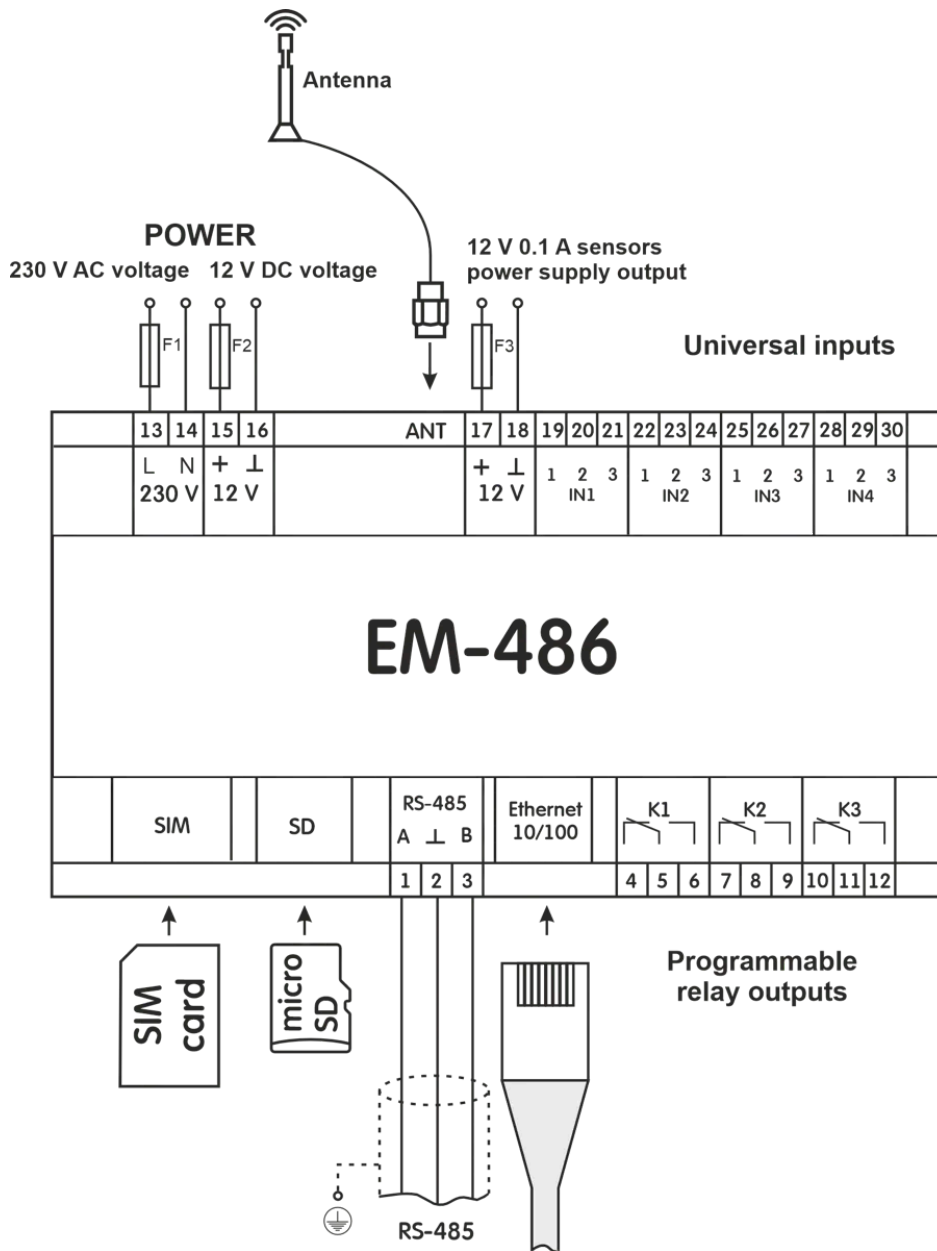

Figure 5.1 – The Device connection diagram

- **F1** – fuse (fuse element), for current of 0.25 A
- **F2** – fuse (fuse element), for current of 2.5 A
- **F3** – fuse (fuse element), for current of 0.25 A
- **Contact "A"** is designed for transferring non-inverted signal
- **Contact "B"** is used for the inverted signal

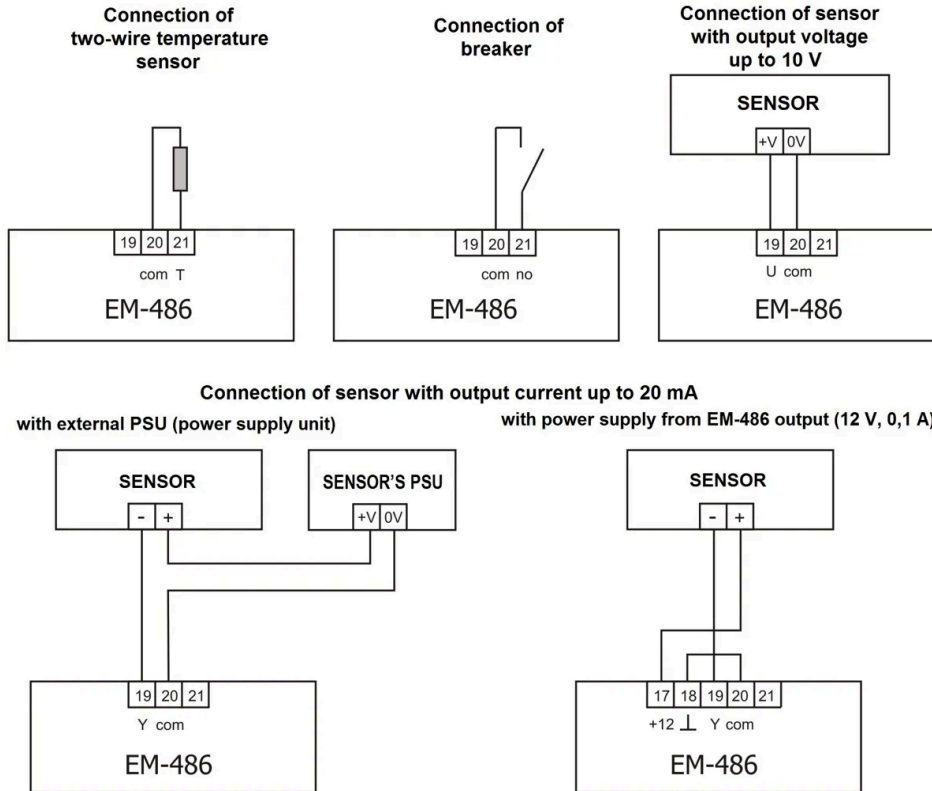

Figure 5.2 – Sensors connection diagram

In case of connection to Ethernet it is necessary to use a cable in a set, or the “twisted pair cable” cable of the Cat.5e category with the 8P8C (RJ-45) tip. Wires fastening should exclude mechanical damage, twisting and insulation abrasion of wires.

 **Caution**

IT IS NOT ALLOWED TO LEAVE EXPOSED PORTIONS OF WIRE PROTRUDING BEYOND THE REMOVABLE TERMINAL BLOCK.

For reliable contact it is necessary to perform tightening of screws of removable terminal block with the force specified in Table 3.1.

When reducing the tightening torque, the junction point is heated, terminal block may be melted and wire can burn. If you increase the tightening torque, it is possible to have thread failure of terminal block screws or the compression of the connected wires.

To improve operational properties of the device it is recommended to install the F1-F3 fuse (fuse element), or the equivalent in power supply circuit for EM-486 (see Fig 5.1).

5.1.3 EM-486 Switching On

1. The device is switched according to the diagram, see Fig 5.1.

2. Switch the cable connection with MODBUS network (twisted pair cable of Cat.1 or higher) to the “RS-485” socket and MODBUS network (or directly to the device with RS-485 interface).

- If EM-486 is connected to the middle of bus RS-485, or if the bus has external terminals at the ends – set the over switches «RS-485 Term.», located next to slot «RS-485», in position OFF.
- If EM-486 is connected at one of the ends of bus RS-485, without a terminal – set the over switches «RS-485 Term», located next to the slot «RS-485», in accordance with wave resistance of bus cable, using the Table 5.1.

Table 5.1 – Resistance of integrated terminator of bus RS-485

Nº	Resistance, Ω	Switch Position	Nº	Resistance, Ω	Switch Position
1	Deactivated	■ ■ ■ ■ ■	13	132	■ ■ ■ ■ ■
2	1000	■ ■ ■ ■ ■	14	120*	■ ■ ■ ■ ■
3	390	■ ■ ■ ■ ■	15	118	■ ■ ■ ■ ■
4	300	■ ■ ■ ■ ■	16	117	■ ■ ■ ■ ■
5	280	■ ■ ■ ■ ■	17	107	■ ■ ■ ■ ■
6	230	■ ■ ■ ■ ■	18	106	■ ■ ■ ■ ■
7	200	■ ■ ■ ■ ■	19	99	■ ■ ■ ■ ■
8	195	■ ■ ■ ■ ■	20	92	■ ■ ■ ■ ■
9	170	■ ■ ■ ■ ■	21	90	■ ■ ■ ■ ■
10	167	■ ■ ■ ■ ■	22	84	■ ■ ■ ■ ■
11	163	■ ■ ■ ■ ■	23	74	■ ■ ■ ■ ■
12	145	■ ■ ■ ■ ■	24	69	■ ■ ■ ■ ■

* – is recommended for cable Cat. 3

3. If EM-486 should be connected to Internet via wire line, to local network or directly to PC – connect the Ethernet communication cable to the slot «Ethernet» and to Ethernet network. The details of connection depending on the type of wire line are resulted in Appendix B - Connections.

4. In case of sensors connection to EM-486 universal inputs «IN». The ways of connection of different types are provided in figure 5.2.

5. In case of controlled elements connection to the outputs of programmable relays of the device «K».

6. To connect a power supply to the socket “230 V”. If necessary, to connect a source of back supply to the power connector “12 V”.

7. If EM-486 should be connected to Internet via wireless connection – insert SIM-card of mobile communication operator in SIM slot; connect the antenna to the slot "ANT" (terminal SMA F).

5.2 Use of the EM-486

5.2.1 General Information

After power supply is provided to the device, all indicators light up, except for «Ethernet» and «GSM», and the device performs the initialization. After this for 2 seconds the indicators, except for indicator of power, light down, and the device proceeds to start the interface of networks connection. At that the display shows general information about the device.

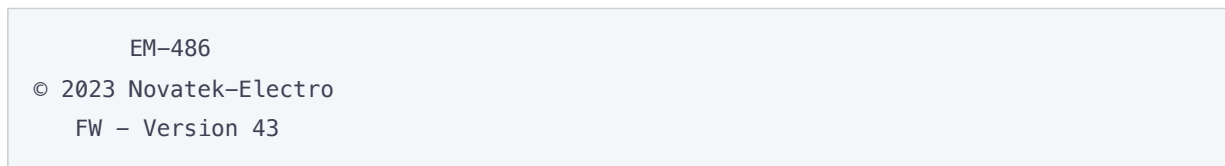

Figure 5.3 – Showing the general information about the device on the display

The start up can take up to 15 seconds, depending on the settings and quality of connection.

Afterwards the device proceeds with performing the user set program of inquiry for sensors and MODBUS devices.

ATTENTION

IF THE ALARM INDICATOR IS CONSTANTLY LIGHTING RED OR PERIODICALLY BLINKING RED AFTER EM-486 IS SWITCHED ON, PLEASE CONTACT THE PLACE OF PURCHASE OR THE MANUFACTURER OF THE DEVICE.

The device provides and supports the connection to Ethernet/GSM networks.

- When the indicator **Ethernet** lights up means that connection to a network is executed successfully. The blinking indicator Ethernet means data transmitting in the network.
- If the indicator **GSM** is blinking one time every three seconds that means the connection to the GSM network is successfully made. If "GSM" LED blinks three times per second, it means enabling the data transmission via GPRS.

The display shows the load of the I/O interfaces, the GSM signal strength and the IP address used:

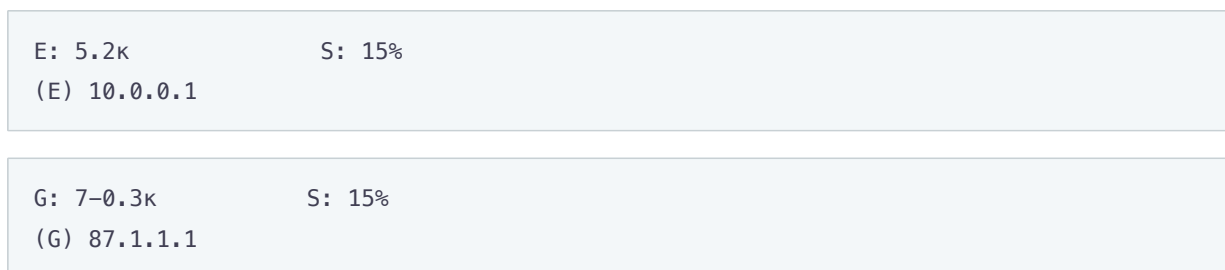

Figure 5.4 – Showing the state of connections on the display

- «E: 5.2k» - rate of transmitting via Ethernet 5.2 kB/s
- «G: 7-0.3k» - the level of GSM signal is 70%, rate of transmitting via GSM GPRS is 0.3 kB/s
- «S: 15%» - Loading of RS-485 is 15%
- «(E): 10.0.0.1» - connection to the local network with the address 10.0.0.1

- «(G) : 87.1.1.1» - wireless Internet access with the address 87.1.1.1

5.2.2 Modes of Operation

5.2.2.1 Connection to Server

EM-486 provides and supports connection to the server specified in the device settings. The light up indicator **Server** means that the connection to server was successfully made. The blinking indicator Server means that there is a data exchange with the server. The data interchange with server is made via one of two protocols: modified MODBUS TCP and MODBUS TCP for reverse connection.

5.2.2.2 Monitoring of Sensors and Devices Connected via RS-485

Controller inquires the registers of MODBUS devices, which are connected via RS-485 on requests from the server. EM-486 measures the reading of connected sensors. The taken readings can be resulted in appropriate scale (according the type of sensor and the settings of the device). The resulted values are shown on the display in the appropriate view:

1: - - -	3: 25C
2: - - -	4: 0.02 A

Figure 5.5 – Showing the state of inputs on the display (sensors 1 and 2 are disconnected, a sensor of temperature 3 – 25°C, a sensor of current 4 – 0.02 A)

The server requests can contain MODBUS EM-486 registers for reading sensor readings, load relay status, current time, etc.

5.2.2.3 Access to MODBUS Network via MODBUS TCP Interface

EM-486 performs the function of MODBUS gateway and waits for network connection via MODBUS TCP protocol to port 502. The MODBUS TCP connection port can be changed by the user. Connection to PC can be made by any programs – MODBUS TCP clients. The client version for Windows software is available for download on the manufacturer’s web-site (<http://novatek-electro.com/en/software.html>).

At inquiry for client connection to MODBUS TCP port, the device checks a list of available connections. If all connections are already engaged, the connection is cancelled otherwise the device adds it into its internal list of service clients (not more than specified number of clients).

At connection with a client the device waits for MODBUS-inquiry from the client. In RS-485 slave mode, RS-485 queries are also received from the MODBUS master.

After receiving the inquiry from the client, the device analyses the inquiry and, depending on code of inquired function and actual rights of the client, processes and blocks it. At blocking the inquiry EM-486 can generate and send to the client the specified by the user code of MODBUS exception (by default – code 1). The client’s authority level is defined by the entered passwords.

If the inquiry is addressed to EM-486, the device does not re-direct it, but processes it and send the reply to the client. In RS-485 master mode, the inquiries to the other devices are re-directed in MODBUS network, and the reply is waited from the device in MODBUS network – at that event the indicator RS-485 lights on. If the data is received or if the time is out the indicator RS-485 lights down.

In redirection mode to a remote server, if communication with remote MODBUS TCP server is set in Ethernet network or GSM, the queries to other devices are also sent to this server, and a response is expected from it.

Note

The response is received from the first responding addressee; therefore, in the MODBUS network and among the addressees accessible via the remote MODBUS TCP server, there should not be devices with the same MODBUS addresses (identifiers).

If the query could not be redirected (for example, in the RS-485 slave mode, if the connection to the remote MODBUS TCP server was terminated), the EM-486 can generate and send the MODBUS user-defined exclusion code to the client (default code is 10).

If there is no reply, EM-486 can generate and send to the client the specified by the user code of MODBUS exception (by default – code 11).

If there is a reply received on inquiry, EM-486 sends it to the client who had sent this inquiry.

5.2.2.4 Access to MODBUS Network via SMS

If there is GSM-connection established, EM-486 receives incoming SMS. All incoming SMS begins with a password. If the password does not match the one specified in settings, SMS is not operated and the reply SMS is not being sent back.

After password through a gap is followed command. The command consists of:

- access symbol ("R" for reading by MODBUS functions with codes from 1 to 4, "W" for writing by MODBUS functions with codes 5 – 6)
- address (identification) of the device in MODBUS network
- resource symbol ("H" for the most frequently used MODBUS registers for storing values, "I" for input registers, "D" for discrete inputs, "C" for flags)
- addresses of resource (register)

For the writing function additionally after the space there is the value for locating by address.

Examples:

- SMS message «abc r1h100» will cause sending the request for reading the register 100 of device 1 (in case when the password for reading via SMS is specified as "abc" in the settings)
- SMS message «stanc12 w2h174 5000» is for writing the value 5000 in register 174 of device 2 (in case when the password for writing via SMS is specified as "stanc12" in the settings)

If the command format is correct, the device generates a MODBUS query, which is further processed in the same way as queries from the other users (see 5.2.2.3).

For the correct response to the query, EM-486 forms the reply SMS. SMS begins with a command prior received from the user. After the command and space there should be the value of register specified in the command (both at reading and writing). The presence of register value in SMS is as confirmation of successful fulfillment of command. For example, SMS «r1h100 2200» means that the value 2200 of register 100 by command for reading from the device 1 has been read.

If the response to the query is MODBUS exception code, EM-486 forms SMS with a reply about exception. SMS begins with a command previously received from the user. After command and space there should be a warning about exception. The warning consists of a line «EXC.» and a number of exceptions. After the warning and space there can be the text description of exception with this number. For example, the message «r3h873 EXC.2 ILLEGAL DATA ADDRESS» means that for the device 3, a register with address 873 is not executable for reading (or is not available).

Table 5.2 – The standard MODBUS exception codes

Code	Exception	Description
1	Illegal function	The received code cannot be processed
2	Illegal data address	The data address specified in the inquiry is not available
3	Illegal data value	The value in the inquiry is not acceptable
4	Device failure	Non-recoverable failure happened when addressee tried to execute the inquired action
5	Acknowledge	The addressee has received the inquiry and is processing it but this action takes a lot of time
6	Device busy	The addressee is processing the command. The client can resend the message later
8	Memory parity error	The parity error was detected when addressee was trying to read the extended memory
10	Gateway paths not available	The gateway cannot redirect the inquiry because there is no path (connection) to the addressee
11	Target device failed to respond to gateway	The gateway has not received a reply on redirected inquiry because the addressee had not replied on time

5.2.2.5 Data Collection and Event Tracking

When the operational logic program is loaded into the internal memory, the device with the specified interval, reads the specified registers (of connected devices or EM-486), and then performs the specified transformations and the evaluation of the received data. The results can be: writing the read values to the log on the memory card, sending SMS, turning on/off of the relay, the entry in the specified register (of connected device or EM-486).

The program downloading to the internal memory is performed from the memory card. The procedure for preparing and loading the program into the device is described in Appendix C - Task Files.

5.2.2.6 Programmable Relays

The relay outputs can switch between two states: normal and active. By default, in the normal state the relay is off, in the active state it is on, and when power is applied all relays remain in the normal (off) state. The normal state of individual relays can be inverted in the settings, such relays will be on when the power is applied. The state of the inverted relay is indicated by a special indication: in the normal state the relay indicator flashes briefly once per second, in the active state - briefly goes out once per second.

Relays can be operated by commands in two modes:

- **Automatically**, relays are switched by commands in the action logic program
- **Manually**, relays are switched by commands via MODBUS TCP

When powered up, the relays remain in automatic control mode until the first manual command to this relay via MODBUS TCP. After that, the relays remain in manual mode until the MODBUS TCP command to return to automatic mode, or until the device is restarted.

5.3 Settings

5.3.1 General Information

The connection settings of EM-486 is made via HTTP protocol or via MODBUS TCP protocol and serves for specifying the main parameters needed for the device operation: types of connected sensors, exchange parameters via RS-485, parameters of address in Ethernet network (if Ethernet is used) and server address to which EM-486 is connected automatically.

The adjustable parameters are described in Appendix D - Registers. The parameters remain saved after the power cut off.

The device setting can be made by two methods:

- Via WEB-interface, as provided in item 5.3.3
- Via MODBUS-interface as described in item 5.3.4

NOTE

WHEN CHANGING THE DEVICE PARAMETERS THERE CAN BE SPECIFIED THE VALUES HINDERING OR PREVENTING THE CONNECTION OF DEVICE IN THE NETWORKS.

Safety remove of the memory card, restarting device or reset of settings to factory values is executed by means of the R button available through a hole on a front panel. The button is pressed with a thin non-conductive object.

The reset of the device to factory settings:

1. Press and hold the reset button R for not less than 8 seconds
2. After 2 seconds of holding the indicator Alarm will light on
3. After 8 seconds of holding the device will restart, the indicators will blink one time
4. Then release the button R

To restart the device with saving of the user's settings:

1. Press and hold the reset button R during time from 2 to 8 seconds
2. When the indicator Alarm lights on, release the button R

To display information about connections or safely remove of the memory card:

1. Press and release the reset button "R", the display shows information about connections, the indicator "Memory SD" will go out
2. Remove the memory card if necessary

5.3.2 Parameters of EM-486

The format of parameters presentation in MODBUS registers is described in the Appendix D - Registers.

5.3.3 Configuring EM-486 through WEB Interface

WEB-browser is used for setting via WEB-interface.

1. Write the device IP-address in your browser (to display address on the display of the device see section 5.3.1) and proceed to the specified address.

Note

If the browser is set to use the proxy server, the access to the device over local network shall be granted only after adding the IP-address into the exceptions list as indicated in the browser documentation.

2. Select "Parameters" for setup of parameters. Password request shall appear before granting access to setup mode (factory setting **11111**).
3. Enter password and press Enter. If the password is correct, you shall be granted access to the setup mode. You will see the settings page. If the password is incorrect, the password request shall be displayed once again.
4. Settings on the settings page are grouped by types and are divided into tabs. Non-configurable settings and measurements are available in the tab "State". Settings on other tabs are listed in Appendix D - Registers.
5. Click **Save** after making changes to the settings. This will check all the changed parameters. If no errors is detected, new parameters will be stored in the memory (new settings will take effect after the following application of settings or restart of the device). In case of any errors detected upon clicking the Save button, none of the parameters is saved, while the names of erroneous parameters are highlighted in red.
6. To apply the settings without restarting the device, you should click "**Apply**" at the bottom of the page. The entered settings will be checked. If the values of the parameters have not errors, the parameters will be stored in the memory of EM-486 and will come into force. Only MODBUS parameters, inputs, outputs and user-defined parameters can be applied without restarting.
7. To set the clock on the tab "Time", press "**Set**" button.
8. Click "**Restore defaults**" to restore the default value of parameters.
9. Click "**Reset**" to stop all connections and interrupt all receive/transmit operations, with the following restart of the device. In case of any changes to the parameters, either introduced or stored in the memory, these changes shall be implemented.

Note

If the addressing parameters in Ethernet network (MAC-address, IP-address) are modified and saved, the browser may not load the page after the restart of the device by pressing the "Reset" button. This can happen as the browser continues to reply over the previous address. In this case, the connection should be made anew.

10. Clicking the **“Leave”** button will close the setup mode and a password request appears once again.

5.3.4 Configuring EM-486 through MODBUS Interface

Setting via MODBUS-interface shall be provided if the device is connected over the MODBUS-client, which is supporting the MODBUS TCP protocol. The connection is established using its IP-address (for display of the address on the device display see the item 5.3.1) with the indication of MODBUS-identifier (factory setting - **111**).

Write the password string into the password input register (see Appendix D - Registers) before setting parameters. Factory set password – is **11111**, i.e. write 49 - ASCII-code for one to record the factory set password to registers 100 – 104 (see Appendix B - Connections). If the password is correct, the mode register takes the value of 1 – setup mode.

The instruction registers, as well as registers for the collection of MODBUS customizable parameters are available for writing in the setup mode. When the required value is written to the registers of customizable parameters, write **2** (instruction for “Saving”) in the instruction register. The accuracy of values for the stored parameters can be checked by comparing the collections of customizable parameters and saved parameters. If collections are the same, new values and settings shall be accepted and saved.

To apply the settings without restarting the device you should write into the parameter of the control command the value **“4”** – command “Save and apply”. Only MODBUS, inputs, outputs and user parameters can be applied without restarting the device. The correctness of the saved parameter values can be checked by comparing the sets of configurable parameters and current settings. If the sets match, then the new settings are accepted and saved.

To cancel the changes in the parameters before saving them, you should write **“9”** value to control command parameter - the “Cancel” command. In this case, the configurable parameters take the values stored.

To reset the saved parameters to factory settings, write **444** (instruction for “Restoring to factory”) in the instruction register.

Can be restart the device for the saved settings to take effect. To restart via MODBUS interface, write **1** (instruction for “Restarting”) in the instruction register.

To exit the setup mode, write **0** instead of any character in password input register. This will clear all the password input registers and instruction register (turn the values to 0).

6 Maintenance

SAFETY PRECAUTIONS

THE TERMINALS AND THE DEVICE INTERNAL ELEMENTS CONTAINS POTENTIALLY LETHAL VOLTAGE.

DURING MAINTENANCE IT IS NECESSARY TO DISABLE THE DEVICE AND CONNECTED DEVICES FROM THE MAINS.

Maintenance of the device should be performed by persons admitted to the operation and have the appropriate permission.

The recommended frequency of maintenance is every six months.

Maintenance Procedure:

1. Check the wires connection reliability, if necessary – clamp with force as specified in Table 3.1
2. Check visually the housing integrity
3. If necessary, wipe with cloth the front panel and the device housing

Caution

It is not allowed to clean the device with abrasive materials or organic compounds (alcohol, gasoline, solvents, etc.).

7 Service Life and Warranty

- **Service life** – 10 years. Contact manufacturer upon the expiry of the service life.
- **Guaranteed storage life** – 3 years.
- **Warranty period** of the device operation is 5 years from the date of sale.

During the warranty period the Manufacturer is responsible for free repair of the device, if the Consumer has complied with the requirements of this Operating Manual.

ATTENTION

IF THE DEVICE HAS BEEN OPERATED WITH VIOLATION OF THE REQUIREMENTS OF THIS OPERATION MANUAL, THE USER WILL LOSE THE RIGHT TO WARRANTY MAINTENANCE.

Warranty service is performed at the place of purchase or by the Manufacturer of the device.

Post-warranty service is performed by the Manufacturer at current rates.

Before sending for repair, the device should be packed in the original or other packaging excluding mechanical damage.

8 Transportation and Storage

EM-486 in the shipping box should be stored indoors at a temperature of -45 to +60°C and relative humidity of no more than 80% with no vapors available in the air, capable of producing harmful effect on the shipping box and device materials.

Please, when returning the device or sending it for warranty or post warranty repair, in reclamation data line in passport, explain in details the reason of returning.

Contact Information

Please contact the manufacturer should you have any questions.

“Novatek-Electro” Ltd.

- **Website:** www.novatek-electro.com
- **Address:** 59, Mykhailo Boltenko (Admiral Lazarev) str., Odesa, Ukraine, 65007
- **Tel:** +38 (067) 565 37 68; +38 (050) 359 39 11; +38 (063) 301 30 40

Appendices

- Appendix A - Versions and Modifications
- Appendix B - Connections
- Appendix C - Task Files
- Appendix D - Registers
- Appendix E - Saving Data to Memory Card
- Appendix F - WEB Interfaces
- Appendix G - Updating Firmware

Appendix A: Versions and Modifications

Firmware Versions

Version	Date of Modification	Remarks
8	31.08.2015	Demo version
12	15.02.2016	Improved accuracy of real-time clock
18	16.09.2016	Reading and execution of task files added; Added adjustment of time delays in task files
24	24.03.2017	Possibility to work with files via WEB-interface added; Improvements for working with time (setting via MODBUS, synchronization with the server, astronomical calculation of sunrise and sunset, automatic transition to summer time); Added storing statistics in memory, powered by the battery; RS-485 slave modes and redirecting requests to remote MODBUS TCP server added
29	08.09.2017	Added support for task files in UTF-8 format; Added support for input GSM connections via MODBUS TCP (for static IP provided by the GSM operator)
30	02.11.2017	Added ability to fulfil the task files more often than 1 second
32	06.12.2017	Added ability to use in the task files the special sequences in the rows - telephone numbers
36	22.02.2018	Added ability to receive the account status from the GSM operator; Improved stability of GSM operation; Clock synchronization and account obtaining commands are added
37	03.08.2019	Parameters in the task file, located in a row for one device, are read by one request; Factory reset also clears the built-in memory of tasks before starting them; Improvements in work with statistics and hours registers; Improvements in the algorithm of the commands for calculating the maxima and minima in the problem files; The number of characters in lines in task files has been increased to 120; Extended support for WEB-browsers
41	20.11.2020	Added ability to log to a memory card; Added import and export of settings to a memory card; Simplified and improved work with the memory card from the WEB-interface; Added JSON and XML APIs for MODBUS authorization and requests; Added a call to the WEB interface over MODBUS connections; Added support for second remote MODBUS TCP server; Improved work with remote MODBUS TCP servers; Improved DNS cache update; Improved Ethernet stability
43	17.07.2023	MODBUS TCP connection encryption feature added; Number of remote MODBUS TCP servers increased up to three; Improvements in working with remote MODBUS TCP servers (sending password, sending ping to maintain connection)

Hardware Versions

Version	Date of Modification	Remarks
1	31.08.2015	Demo version
2	18.03.2016	Connection of the GSM module is improved; Improved insulation of operating lines of relay outputs
3	12.07.2016	Improved accuracy of real-time clock

Appendix B: Connections

NOTE

CONNECTING THE INCORRECTLY SET DEVICE TO THE DATA TRANSMITTING NETWORK CAN INFLUENCE THE COMMUNICATION BETWEEN THE OTHER DEVICES. CONNECTION OF DEVICE EM-486 TO ETHERNET NETWORK NEEDS MUTUAL PARITY OF CONNECTED DEVICES SETTINGS. AS A RULE, ALL CONNECTIONS TO THE NETWORK LINKING MORE THAN 2 DEVICES, SHOULD BE MADE BY QUALIFIED PERSONNEL (NETWORK ADMIN).

1. IP Addressing

When devices are communicating over Ethernet network using TCP/IP protocol, every device is using a set of IP-addressing settings to identify the sender and receiver of the data. The device memory contains a personal and unique, within a single subnet, IP-address (four bytes are written as four integers, separated by dots, in the range of 0-255), subnet mask, which is the same for all devices within the subnet (written similar to IP-address), and IP-address of the gateway, which is used to communicate with other networks.

Proper communication between devices of a subnet is possible under several conditions:

1. **All devices of a subnet have similar mask.** Most of small LANs are using 255.255.255.0 mask.
2. **Mask starts with a group of bits set to 1**, followed by a group of bits turned to 0.
3. **All bits set to 1 in the mask are similar for all the IP-addresses of devices in subnet** and indicate the subnet address. 192.168 is most frequently used address in LANs for the mask 255.255.255.0. The third byte may be used as a subnet number in a complex LAN. In smaller LANs, the third byte is usually equal to 0.
4. **A set of bits in IP-address of the device, which is set to 0 in the mask, is unique to each device** within the same subnet.

In most cases, the device like router, which is already communicating with other networks, is switched to the network. This device often gets the following address 192.168.0.1, 192.168.0.100, or 192.168.0.101. In this case, other devices in the network shall have this IP-address of the device as the gateway address. This address is not necessary for communication between devices in a subnet, and is only used to connect devices of one subnet to devices of other networks.

Factory Addressing Settings

Parameter	Value
Addressing using DHCP	Yes
IP-address	192.168.0.111
Subnet mask	255.255.255.0
Gateway	192.168.0.1

With EM-486 factory settings, for communication with it via Ethernet there are 2 possible ways:

a) The network uses a router or other DHCP server, which assigns IP addresses to new devices. In this case, it is sufficient to connect the EM-486 to the network, and after some time the obtained IP address appears on the display. The address "0.0.0.0" means that the desired value has not been received yet. The address "192.168.0.111", obtained after 30-60 seconds after running EM-486, may mean that getting address from the DHCP server failed and the device uses a static address.

b) The network is not able to use DHCP, or EM-486 is connected directly to the computer (or another device-client on the same subnet). In this case, EM-486 will switch to static addressing after some time (30-60 seconds) after starting. A client device should use a mask 255.255.255.0 as a mask and address starting with 192.168.0. The fourth byte of the address can take any value in the range from 1 to 255, except for 111.

If the connection between EM-486 and a client device is not provided directly but via a network with a number of devices, the mentioned address cannot be equal to any of the addresses of other devices on the subnet. If network has several devices with the mask and the first three bytes of the IP-address, which are different from those specified in the factory settings, or the EM-486 factory IP-address is already taken, the configurable device should be temporarily removed from the network to avoid addressing conflicts and establish a communication between this device and EM-486 directly. This will allow configuring the device and EM-486 for direct communication or switching EM-486 to the network.

2. Configuring the Client Device

The device addressing is set according to documents and software it uses.

Below is an example of configuring the personal computer (PC) on Windows 7/8/10/11 to communicate directly with the EM-486 on factory settings.

Opening Network Connections in Windows

For Windows 11:

1. Log in to the OS under an administrator account
2. Select "Start → Settings"
3. Select the "Network and Internet" category
4. Expand the "Advanced Network Settings" group
5. Select "Advanced network adapter settings"

For Windows 7/8/10:

1. Log in as administrator
2. Select Start → Control Panel
3. If control panel items are divided into categories, select "Network and Internet"
4. Go to "Network and Sharing Center"
5. In the task bar (on the left), select "Change adapter settings"

Configuring the Network Connection

1. In the Connections window, select the desired connection via an adapter with the addressing that you want to change. Many computers have only one adapter and one connection, which will be displayed in this window. If the window shows several connections, select the connection you want, using the adapter name in the information on connection or contact your system administrator.

2. Click the icon of the connection with the right button, and select "Ethernet Properties" in the drop-down menu. The Properties window opens.

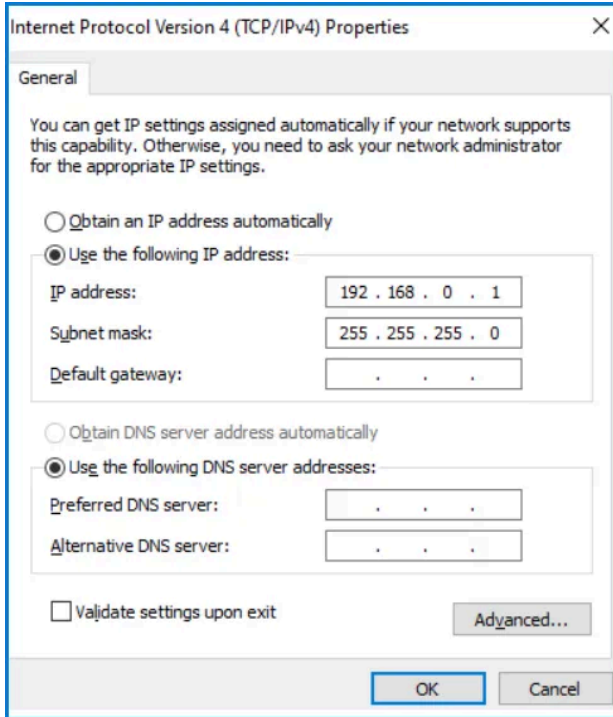

Figure B.1 – Connection properties window in Windows OS

3. Select "Internet Protocol Version 4 (TCP/IPv4)" from the list of connection components in the next window. Make sure that the component is enabled (flagged in the list). Click "Properties". The TCP/IPv4 properties window opens.

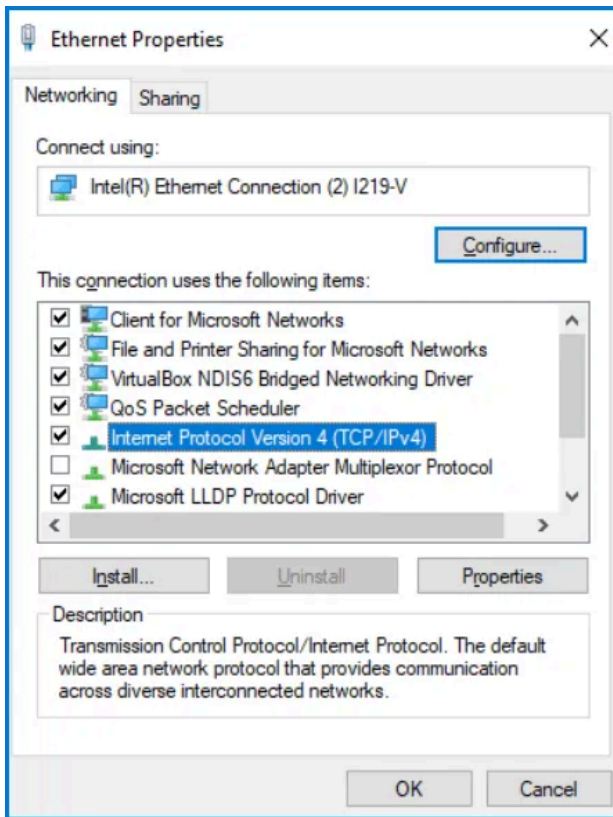

Figure B.2 – TCP/IPv4 properties window in Windows OS

4. Select "Use the following IP-address".
5. Specify the address in the "IP-address" field within the range from 192.168.0.1 to 192.168.0.255 (except for 192.168.0.111, which is used by EM-486).
6. Specify "255.255.255.0" in the "Subnet Mask" field.
7. The fields "Default Gateway", "Preferred DNS server", and "Alternative DNS server" should be left blank.
8. Press "OK" to close the Protocol Settings window.
9. Press "OK" to close the Connections Settings window.
10. If prompted by the OS to restart the PC after closing the windows, answer yes.

3. Connection to Internet via Ethernet

Caution

The user is strongly recommended to connect the device to Internet under the supervision of the LAN system administrator and/or representative of Internet service provider.

Use the following guidelines to connect the device to Internet:

1. **Acquire a dedicated line with a static IP-address** from your Internet Service Provider (hereinafter referred to as ISP). If static IP is unavailable, a part of functions (direct connection via MODBUS TCP or via the WEB interface) can be unavailable from Internet, at the same time connection to the server in active mode can be used.
2. **Direct connection of the device to the ISP cable is not recommended.** In case of a router connection, the ISP cable is connected to the "Uplink" socket on the router (It is usually marked with color and has no numbers. The marking depends on the router manufacturer, see the router documentation). The straight-through (supplied) Ethernet cable is used for connecting device to the router.
3. **Set the router for Internet connection** as per ISP recommendations. The router settings should also provide for the redirection of requests, which are coming to static IP-address provided by the ISP, to the device IP-address (factory setting - 192.168.0.111). If for a dedicated line the static IP address is fixed in Internet, and direct access from Internet to the device HTTP, MODBUS TCP servers is required, then in settings it is required to specify ports of redirection – for a local IP address of a device on which there is a redirection, it is necessary to specify 80 (for access to the WEB-interface), 502 (for access on MODBUS TCP). It will also be necessary to disable DHCP in the settings of EM-486, or configure the router for the provision of EM-486 via DHCP of always the same IP-address.
4. **Verify if the Internet connection is protected** by standard means (see section 5 below).
5. **When referring the device via Internet**, use IP-address provided by your ISP.

4. GSM Connection

Caution

The user is strongly recommended to connect the device to Internet under the supervision of the LAN system administrator and/or representative of Internet and mobile service providers.

Make sure that your tariff plan includes providing GPRS service (for connection to Internet) and/or receiving and sending SMS messages (for control via SMS).

To connect the device via GSM, use the following recommendations:

1. **From GSM provider** (next in the text as a provider) you should get a SIM-card.
2. **Insert the SIM-card** in the device and connect the appropriate antenna to have a proper radio signal in the place of the device location.
3. **After starting the device**, make sure that SIM-card has correct identification – after the communication initialization, the indicator GSM keeps on blinking; if the indicator goes out for a time longer than 4 seconds, check the SIM-card, antenna and a level of GSM signal on the display of the device.
4. **If GPRS is used for Internet connection**, make sure that the provider and connection settings are defined via code of SIM-card. When you enter the Internet the GSM indicator blinks 3 times per second; if the indicator flashes less frequently, check the APN settings.
5. **In case of necessity**, manually set the APN in accordance with the provider's recommendations.

5. Protection of Connection

EM-486 has basic protection against unauthorized access over network:

- Access for writing and/or reading via MODBUS TCP or via SMS can be deactivated in settings.
- Device settings can be changed remotely by entering the password (minimum 5 characters). Entering several incorrect passwords while trying to determine the correct one is blocked by the device.
- Access passwords can be set for restriction of writing and/or reading via MODBUS TCP or via SMS.
- When entering the password, all settings shall be only available to a given client using a given protocol. In case of no requests from the client over the long period, the access returns to locked mode.

Danger

AT ANY CONNECTIONS, EXCEPT: GSM TRANSMISSIONS, COMMUNICATION OF TWO DEVICES VIA MODBUS TCP BETWEEN EACH OTHER AND COMMUNICATION WITH THE DATA COLLECTION SERVER VIA A SPECIALIZED PROTOCOL - PASSWORDS ARE SENT IN UNENCRYPTED FORM. IF THE PASSWORD IS CORRECTLY ENTERED, ACCESS IS OPENED IN AN UNPROTECTED CONNECTION.

- The device protection system is not designed to counter malicious network attacks (especially those, which are not trying to get access to the device but to block it instead).
- In case of complex and large networks (especially when providing access to the EM-486 via Internet), the users are recommended to separate the device from unprotected networks with standard protective equipment (router, configured to filter the transmissions, Firewall, etc.).

6. Connection to Server

EM-486 has the mode of constant communication with the data collection and management server. Data collected by the device is transferred and accumulated on the server; this data can accumulate in the internal memory of the device when connection is failed and transmitted to the server when connection is restored.

As a server there can be, for example, the system **Overvis** (Internet-address is overvis.com).

Overvis – is a system for monitoring and remote control of technological processes. Overvis makes it possible to read the data and make control over the devices including EM-486, provided there is a connection with them, and in the future to convert and view them in a convenient form, to receive alarm messages as SMS or E-Mail.

EM-486 factory settings are prepared for connection to Overvis.

Overvis system supports a special manner of identification which is used in EM-486. Thereat the devices are verified by a unique MAC-address which is sent to the server at each connection session.

Device Registration Methods

The device registration for a user of the Overvis system is possible in two ways:

- a) If the device has a sticker with a QR code – it is required to read the code and follow the link or enter a link from the stickers manually and follow the instructions of the server.

b) Enter the activation code to a user account of Overvis. The code represents the number of 8 characters and is displayed on the display and on the status page of the WEB interface of the device after connecting to the server. When you enter code, EM-486 is "attached" to a user account.

Connecting to Overvis Using Activation Code

To connect a new device to the Overvis system using activation code you should:

1. Connect the device to Internet via one of the above-mentioned methods.
2. Make sure (by information on the display or on the page of parameters of the device WEB-interface state) that the connection to the server is made and the activation code is received.



Server:
(E) 85629051

Figure B.3 – Image of the activation code on the display (E - connection to server via Ethernet)

3. If for this device that is reconnected to Overvis, information is displayed that the connection is activated, or connection without a code, then for security reasons, you must click the "Restart activation" button at the bottom of the status page, in the settings via the WEB interface, to remove the device from Overvis. This ensures that the EM-486 will only be used by authorized users.
4. Using the instruction on the site of Overvis system, connect to EM-486 with activation code; after activation during the connection to the server there will be shown on the device display a message «activated».

The message "no code" means that the device has been registered using the QR code on the sticker.



Server
(E) active

Figure B.4 – Display image of activation state

For information about EM-486 connection to other servers, contact the Device manufacturer.

Appendix C: Task Files

1. General

After running, EM-486 starts execution of the program for logic of action, if it was placed earlier in the built-in memory. If there is no program in the built-in memory, EM-486 searches for and checks the task files placed in the folder "TASKS" on the memory card, provided the card is formatted in the FAT or FAT32 format. The correctly discovered files are read in the built-in memory and form the logic program of actions. Such a reading runs once after startup or after installing a new memory card, only if the built-in memory does not contain the programs.

To clean the internal memory, you should:

1. Enter EM-486 parameter setting via WEB interface (see Manual, para 5.3.3)
2. Go to the tab "Files"
3. Press the button "Clear built-in tasks memory"
4. If the result of the reading the program is not displayed immediately in the tab "Files", refresh the page a few seconds later

Note

The program in the internal memory is deleted when updating the firmware. If the memory card with the task files remains installed in the EM-486, the program will automatically read again after the update.

The tab "Files" indicates the result of reading the folder "TASKS", including the number of discovered and read files. If during reading and verifying the program errors were detected, then it indicates the type of error, file and line number of the file error. If the program consisted of several files in the folder "TASKS", then the internal memory will read all files except those in which errors are detected. Therefore, during error correction you should compare the number of discovered and read files and if some were read, to clear again the internal memory to re-read the program.

Files can have arbitrary names and extensions and placed in subfolders of the folder "TASKS". Files placed directly in the folder TASKS, allow you to use MODBUS ID default in the text, equal to MODBUS ID of the device EM-486. Files placed in subfolders in the folder "TASKS" with names from "1" to "247", allow to use the text MODBUS ID default name of the subfolder. Therefore, if the program logic is divided into tasks so that each is associated with its connected device, it is recommended that files relating only to EM-486, to be placed in the folder "TASKS" and files related to primarily the other device, to be put in a subfolder with the name of the MODBUS ID of this device. This allows you to change the list of managed devices by copying and renaming the subfolders, and create universal and portable files of the tasks.

2. Files of the Tasks

File of tasks describes repeated after a specified time interval the set of actions for gathering, processing and comparing the data and special actions after fulfillment of the preset conditions according to the processing results.

The task file is divided into sections which in turn are divided into lines.

The section is part of the file that starts with "!" and the name of the section written in a row.

Correct example:

```
!META
* UPDATE 60
!PARAMS
...
```

Incorrect example:

```
META
UPDATE 60
PARAMS
...
```

If the section allows you to refer the lines in it, then all the lines of the section are numbered, otherwise instead of a number of the line will be put the sign *. The format of the line is different in each section. The number and order of sections does not matter (sections can be interrupted and then be continued after one or more sections), if two rules are fulfilled:

1. If a section with numbered lines is found for the first time, the numbering starts with 0, otherwise, numbering continues from the previous section of the same name.

Correct example:

```
...
!VARS
0 VAL 0
!CONDS
0 VAREQVAL V0 0
!ACTS
0 RELAYON 1 2
1 RELAYOFF 1 2
!REACTS
* C0 ACT A0
!CONDS
1 NOT C0
!REACTS
* C1 ACT A1
...
```

Incorrect example:

```
...
!VARS
0 VAL 0
!CONDS
0 VAREQVAL V0 0
!ACTS
0 RELAYON 1 2
1 RELAYOFF 1 2
!REACTS
* C0 ACT A0
!CONDS
0 NOT C0
!REACTS
* C1 ACT A1
...
```

2. Link to next line should be below the line that is referenced.

Correct example:

```
...
!CONDS
0 VAREQVAL V0 0
1 NOT C0
...
```

Incorrect example:

```
...
!CONDS
0 NOT C1
1 VAREQVAL V0 0
...
```

The file should end with an empty line or a comment. The file should not have extra spaces, including at the end of lines. The file can contain comment lines that begin with #, and are ignored when reading the file.

Correct example:

```

...
# this is comment
!VARS
# number of seconds in a minute
0 VAL 60
1 VAL 1
...

```

Incorrect example:

```

...
# this is comment
!VARS
0 VAL 60 # number of seconds in a minute
1 VAL 1
...

```

Sections Assignment

Section	Description
META	General information and the file run settings
DEVICES	MODBUS devices capabilities
PARAMS	Parameters, registers and bits of MODBUS devices, and type conversion
VARS	Variables, transformation of parameters and calculations
PHONES	Phone numbers to which SMS are sent
STRS	Texts of messages to send to SMS
CONDS	Comparison of variables, the conditions for performing actions
ACTS	Actions that can be performed
REACTS	Reactions that determine under what conditions you will run the actions

2.1 META Section

It contains the general information about the file and settings for its execution, and is responsible for the particularities of the program cycle fulfillment (the so-called "updates"), including the frequency of updates. Lines in it do not have numbering, instead of index is *. Each line has the following format:

```
* <modifier type> <argument>
```

The types of the arguments are the following:

- <int> - 32-bit signed integer
- <uchar> - 8-bit unsigned integer
- <ushort> - 16-bit unsigned integer

Types of Modifiers

Modifier	Description
PROTOCOLVERSION <int>	Version of the file: It prevents the processing of files with outdated firmware EM-486. The version described in this document is 9
UPDATE <int>	Frequency of the program cycle fulfillment (update rate) in seconds: Every cycle has the reading of parameters, calculation of variables values, defining operation conditions and implementation of response to these conditions. The frequency determines only the approximate time of the cycle restart. If during the task execution the time of the new update (this or another task) will be skipped, this new update will be postponed until the end of the running cycle. If one or more updates are missed for the deferred update, these additional updates will not be performed. The minimum value is 1 second. For higher speeds, the UPDATE DIVISOR modifier should be used. By default, if a modifier is not specified, it equals to 60
UPDATEDIVISOR <int>	Update divisor. It allows you to speed up the update rate. If the divisor is 0, update cycles are performed with an accuracy of not more than 1 second. For other values, the accuracy is not more than 0.002 seconds, and the resulting frequency, equal to the value of the UPDATE / UPDATE DIVISOR fraction, cannot be greater than 60 or less than 0.002 seconds. Practical limiting speed, as a rule, is less. The speed is significantly reduced when using SMS and parameters in the task file, which are accessed through RS-485 and GSM interfaces. By default, if no modifier is specified, it is 0
PARAMACTUAL <ushort>	Frequency of reading the parameters in seconds: It allows optimizing the number of readings of parameters. At the moment of the updating the parameter it is checked how many seconds ago it was read last time, and if this time is not more than the value PARAMACTUAL, then upgrade option will not be read and the last read value of the Parameter will be accepted as current one. Thus, if the total program consists of several files, reading the same parameters, the number of readings of these parameters and the excessive load on the communication channels can be reduced. For the value 0 – with each update the parameter values will be read again. By default, if a modifier is not specified, it equals to 0
PARAMRETRIES <uchar>	Number of times to repeat reading in case of error: The value 0 for the programming cycle there will not be more than one attempt to read the parameter. For 1 – it will be made up to two attempts to read, etc. Calculations and reaction to conditions can be performed even without a successful reading of all parameters, if they have sufficient known data. By default, if a modifier is not specified, it equals to 0
PARAMTIMEOUT <int>	Time of waiting for response to MODBUS query in milliseconds: It is used if in the settings of EM-486 the total timeout MODBUS is more than frequency of update of this file, or if the exception code generation is disabled if no MODBUS response. By default, if a modifier is not specified, it equals to 1000
PARAMLOADRATIO <uchar>	Maximum load of RS-485 channel, in percent: After each query a delay is added, depending on the waiting time of the last response that allows other clients to send queries and receive responses. A value

Modifier	Description
har>	of 100 generates the minimum possible delays (it is not recommended). A value of 50 means a delay equal to the time of waiting for a response. A value of 25 means a delay of 3 times exceeding the response time. By default, if a modifier is not specified, it equals to 25

Example:

```
!META
* PROTOCOLVERSION 9
* UPDATE 5
* PARAMRETRIES 2
```

2.2 DEVICES Section

It contains the capabilities of MODBUS devices, the settings of not specified here devices will be treated the same as for the device with maximum features and functions. The lines in this section do not have numbering, instead of an index is *. Each line has the following format:

```
* <MODBUS ID of device> <record type> <argument 1> [argument 2]
```

MODBUS device ID: a number from 1 to 247. "0" – is the broadcast, it can be used to configure recording simultaneously to all devices that support the broadcasting (the argument 1 in this case is defined, but not used). * instead of the MODBUS ID means a device by default for this folder (EM-486, if the file is placed directly in the program folder, or device with the MODBUS ID of the name of the subfolder, if the file is placed in the subfolder named "1" to "247").

Lines with different types or arguments, but with the same MODBUS ID are not permitted. These lines being in different files in the folder of programs are also considered to be incorrect.

Arguments type: <uchar> – 8-bit unsigned integer.

Types of Records

Record Type	Description
WRHANY <uchar> <uchar>	Device can write both as a function of 6 and function of 16 in the storage registers. The first argument specifies how many registers can be read in one query; the second one determines how many you can record in a single query
WRHMULTIPLE <u char> <uchar>	Device can write only using function 16 in the storage registers. The first argument specifies how many registers can be read in one query; the second one determines how many you can record in a single query
WRHSINGLE <uch ar>	Device can write only using function 6 in the single storage register. The argument specifies how many registers can be read in one query
WRHDENIED <uch ar>	Device can't write to the storage registers. The argument specifies how many registers can be read in one query

Example:

```
!DEVICES
* * WRHANY 50 50
* 3 WRHSINGLE 4
```

2.3 PARAMS Section

It contains parameters, their addressing, and conversion between types (how they are used by the device). When reading the settings are always converted from the specified type to the default type for the program EM-486 (INT32 – 32-bit signed integer). When recording the inverse transform is performed. The lines in this section are in ascending order, starting from zero. Each line has the following format:

```
<index> <MODBUS ID of device> <data type> <register table> <address>
```

- **Index:** the sequential number of the line
- **MODBUS ID of device:** a number from 1 to 247. "0" – is the broadcast, it can be used for writing only. * instead of the MODBUS ID means a device by default for this folder (EM-486, if the file is placed directly in the program folder, or device with the MODBUS ID of the name of the subfolder, if the file is placed in the subfolder named "1" to "247")
- **Tables of registers:**
 - H - storage registers (most frequently used registers)
 - I - input registers
 - D - digital inputs
 - C – flags
- **Address:** a number from 0 to 65535

Data Types

Type	Description
0 UINT16	16-bit unsigned integer. It occupies one register
1 INT16	16-bit signed integer
2 INT16BLE	16-bit signed integer with reverse order of byte transfer
3 INT32	32-bit signed integer. It occupies 2 registers
4 INT32BLE	32-bit signed integer with reverse order of bytes
5 INT32WLE	32-bit signed integer with reverse order of words
6 BIT	1-bit value for the digital inputs and flags
7 INT32BE	32-bit signed integer. For compatibility, the analog to INT32

Type	Description
8 F32EP0R	32-bit rounded to an integer with floating point
9 F32BLEEP0R	32-bit big-endian floating point
10 F32WLEEP0R	32-bit reverse word order and floating point
11 F32EP1R	32-bit floating point multiplied by 10, rounded
12 F32BLEEP1R	32-bit big endian floating point × 10
13 F32WLEEP1R	32-bit reversed word order floating point × 10
14 F32EP2R	32-bit floating point multiplied by 100, rounded
15 F32BLEEP2R	32-bit big-endian floating point × 100
16 F32WLEEP2R	32-bit reversed word order floating point × 100
17 F32EP3R	32-bit floating point multiplied by 1000, rounded
18 F32BLEEP3R	32-bit big endian floating point × 1000
19 F32WLEEP3R	32-bit with reverse order of words and floating-point × 1000

Example:

```
!PARAMS
0 3 UINT16 H 240
```

2.4 VARS Section

It contains variables, processing the parameters and other calculations (e.g. the sum of the parameters). The lines in this section are in ascending order, starting from zero. Each line has the following format:

```
<index> <source type> <argument 1> [argument 2]
```

- **Index:** the sequential number of the line

The types of the arguments:

- **<bit number>** - is the bit number of the parameter from 0 and above. For 16-bit parameters it is no more than 15. For 32-bit parameters it is not more than 31
- **<int>** - 32-bit signed integer
- **<param ref>** - parameter reference of format Pn, where n is index of the parameter
- **<var ref>** - variable reference of format Vn, where n is index of the variable
- **<cond ref>** - reference to the condition of the Cn format, where n is the condition index

Types of Sources

Source Type	Description
COPY <var ref>	Copy the variable
VAL <int>	Set to the specified value
PARAMVAL <param ref>	Copy the value of the parameter
PARAMBIT <param ref> <bit number>	Copy one bit of the parameter value
PARAMERC <param ref>	Copy the last error code of MODBUS parameter
PARAMERN <param ref>	Copy the error counter of reading the parameter (it is reset to 0 after successful reading, and is incremented by 1 after each update, for which read attempts of the parameter was terminated)
VARADDVAR <var ref> <var ref>	Sum of two variables
VARADDVAL <var ref> <int>	Sum of the variable and the specified value
VARMULVAR <var ref> <var ref>	Product of two variables
VARMULVAL <var ref> <int>	Product of the variable and the specified value
VARSUBVAR <var ref> <var ref>	Difference of two variables
VARSUBVAL <var ref> <int>	Difference between the variable and the specified value

Source Type	Description
VARDIVVAR <var ref> <var ref>	Quotient of two variables (the remainder is discarded)
VARDIVVAL <var ref> <int>	Quotient of the variable and the specified value (without remainder)
VARMODVAR <var ref> <var ref>	Remainder of the division of two variables
VARMODVAL <var ref> <int>	Remainder of the division of the variable by the specified value
VARSMIN < var ref> <var ref>	Minimum of all variables in the specified range
VARSMINID X <var re f> <var r ef>	Number of the minimum variable in the specified range
VARSMAX < var ref> <var ref>	Maximum of all variables in the specified range
VARSMAXID X <var re f> <var r ef>	Number of the maximum variable in the specified range
VARSSUM < var ref> <var ref>	Sum of the all variables in the specified range
VARSELBY C <var re f> <cond ref>	Select one variable from the range by condition. The value of that variable from the range (from the specified to the current one), the order of which in the range corresponds to the first condition that is fulfilled (starting from the specified one). To use such a variable, it is necessary to describe not only a list of variables above it, but also a list of conditions. Since the conditions usually refer to variables, such a list of conditions is placed "in a break" in the variable list, after which the variable is placed in the continued "VARS" section. It is recommended that the last condition in the list be described in such a way that it is always fulfilled to limit the list

Example:

```
!VARS
0 PARAMBIT P0 0
```

2.5 STRS Section

It contains the text used as message for actions. The lines in this section are in ascending order, starting from zero. Each line has the following format:

```
<index> <text>
```

- **Index:** the sequential number of the line

Special sequences in the line text:

- *U* - MODBUS ID by default (reference to the number in the folder name where the file is located)
- *M0* - telephone number of the main subscriber (link to the line in the device settings)
- *<var ref>* - the value of the variable (reference to the variable, for example *V2*)
- ** - means a single character *

Example:

```
!STRS
0 *U* - alarm 21: TS2 short circuit
```

2.6 PHONES Section

It contains texts that are used for addressing SMS. The lines in this section are in ascending order, starting from zero. Each line has the following format:

```
<index> <text(phone number)>
```

- **Index:** the sequential number of the line

Special sequences in the line text:

- *U* - MODBUS ID by default (reference to the number in the folder name where the file is located)
- *M0* - telephone number of the main subscriber (link to the line in the device settings)
- *<var ref>* - the value of the variable (reference to the variable, for example *V2*)
- ** - means a single character *

Note

If there are no numbers in the phone number other than 0, then SMS to this number will not be sent.

Example:

```
!PHONES
# Ivanoff - comment
0 067*v0*
```

2.7 CONDS Section

It contains conditions for comparison of variables and triggering actions. The lines in this section are in ascending order, starting from zero. Each line has the following format:

```
<index> <condition type> <argument 1> [argument 2]
```

- **Index:** the sequential number of the line

The types of the arguments:

- <int> - 32-bit signed integer
- <cond ref> - reference to the condition of the format Cn, where n is the index of conditions
- <var ref> - reference to the variable of format Vn, where n is the index of the variable

Condition Types

Condition Type	Description
IF <cond ref>	Copy of the condition
CONDIS <int>	Set to the specified value. The condition is met if the value is not 0. It can be used for debugging or for unconditional actions for each update cycle
NOT <cond ref>	Logical NOT. The condition is satisfied, when the referred condition did not happen and vice versa
AND <cond ref> <cond ref>	Logical AND. Condition is satisfied, when both referred conditions happened
OR <cond ref> <cond ref>	Logical OR. The condition is satisfied, when any referred conditions occurred
VAREQVAR <var ref> <var ref>	Comparison of two variables. The condition is fulfilled, if they are equal
VAREQUAL <var ref> <int>	Comparison of a variable with a specified value. The condition is fulfilled when a variable by reference is equal to the specified value
VARNEVAR <var ref> <var ref>	Comparison of two variables. The condition is fulfilled, if they are not equal

Condition Type	Description
VARNEVAL <var ref> <int>	Comparison of a variable with a specified value. The condition is fulfilled when a variable by reference is not equal to the specified value
VARGRVAR <var ref> <var ref>	Comparison of two variables. The condition is fulfilled when the first variable by reference is more than the second variable
VARGRVAL <var ref> <int>	Comparison of a variable with a specified value. The condition is fulfilled when a variable by reference is more than the specified value
VARLEVAR <var ref> <var ref>	Comparison of two variables. The condition is fulfilled when the first variable by reference is no more than the second variable
VARLEVAL <var ref> <int>	Comparison of a variable with a specified value. The condition is fulfilled when a variable by reference is no more than the specified value
VARLSVAR <var ref> <var ref>	Comparison of two variables. The condition is fulfilled when the first variable by reference is less than the second variable
VARLSVAL <var ref> <int>	Comparison of a variable with a specified value. The condition is fulfilled when a variable by reference is less than the specified value
VARGEVAR <var ref> <var ref>	Comparison of two variables. The condition is fulfilled when the first variable by reference is no less than the second variable
VARGEVAL <var ref> <int>	Comparison of a variable with a specified value. The condition is fulfilled when a variable by reference is no less than the specified value

Example:

```
!CONDS
0 VAREQVAL V0 1
1 NOT C0
```

2.8 ACTS Section

It contains actions that can be performed (action is performed only by references from the section of the reactions REACTS, during the performance of the conditions indicated there). The lines in this section are in ascending order, starting from zero. Each line has the following format:

```
<index> <action type> <argument 1> [argument 2]
```

- **Index:** the sequential number of the line

The types of the arguments:

- <int> - 32-bit signed integer

- <alarm reason> - is the number of causes of the accident – when any of the accidents is enabled, red LED of accident is on, so to turn off the indicator, each of them needs to be turned off
- <relay reason> - is the number of reason to enable the relay; the relay may be on for reasons with different numbers, and remains in the active state until all causes for this relay will not be switched off
- <relay number> - is the number of relay, it can be 1, 2 or 3
- <param ref> - reference to the parameter of format Pn, where n is the index of the parameter
- <phone ref> - reference to the phone of format Hn, where n is the index of the phone
- <str ref> - reference to the line of format Sn, where n is the index of the line
- <var ref> - reference to variable of format Vn, where n is the index of the variable

Types of Actions

Action Type	Description
ALARMON <alarm reason>	Turn on alarm LED. Red LED alarm will be on to the action of ALARMOFF with the same number of <alarm reason>
ALARMOFF <alarm reason>	Turn off alarm LED
RELAYON <relay reason> <relay number>	Turn on the relay. Hold the relay on up to the action of RELAYOFF with the same number of <relay reason>
RELAYOFF <relay reason> <relay number>	Turn off the relay
PARAMWRVAR <param ref> <var ref>	Record the parameter with the value of the variable
PARAMWRVAL <param ref> <int>	Record the parameter with the set value
SENDSMS <phone ref> <str ref>	Send SMS
PARAMLOG <param ref>	Write the parameter value to the log (see Appendix E - Memory Card)
PARAMCOMMENT <param ref> <str ref>	Write parameter value to log with comment. Comments are written only in tabular log format
PARAMLOGCHGVAR <param ref> <var ref>	Write the parameter value to the log if it has changed by more than the specified variable
PARAMLOGCHGVAL <param ref> <int>	Write the parameter value to the log, if it has changed by more than the specified value

Example:

```
!ACTS
0 RELAYON 5 1
```

2.9 REACTS Section

It contains the responses, a list of actions that must be performed under specified conditions. Lines do not have numbering, instead of an index is *. Each line has the following format:

```
* <cond ref> <response type> <act ref>
```

The types of the arguments:

- <cond ref> - reference to the condition of the format Cn, where n is the index of the condition
- <act ref> - reference to the action of format An, where n is the index of the action

Types of Response

Response Type	Description
<cond ref> ACT <act ref>	Perform once. If the condition occurred, but did not occur in the previous update, the action will be performed once
<cond ref> REPE AT <act ref>	Perform each time. Regardless of the previous state, the action will be executed. The action will be executed even, if the state conditions are not defined in this update due to reading errors, but this condition has already happened earlier

Example:

```
!REACTS
* C0 ACT A0
* C1 REPEAT A1
```

3. Examples of Programs

For complete example programs demonstrating task file usage, see Task File Examples.

Appendix D: Modbus Registers

Format of Parameters Presentation in MODBUS Registers

Parameter	Range of Values	Description	Number of Occupied Registers
Number	0 – 65535	Whole number (16 bit) in standard range of MODBUS register values	1
Number	-32768 – +32767	Whole number (16 bit) in additional arithmetic	1
Number	0 – 4294967295 in two registers, upper part – the first one	Whole number, which value can exceed the limit for MODBUS register (65535)	2
Number	-2147483648 – +2147483647 in two registers, the upper part is the first	An integer (32 bits) in complement arithmetic	2
Line of symbols	In each register, a number from 0 to 255 – ASCII-code of symbol or 0 (the end of line)	A set of values every of which is equal to symbol code in ASCII encoding. If the line is shorter than the maximal length then after the last symbol there should be code 0	Max. length of line for the parameter
IP-address (IP-mask)	In every register – one byte (0 – 255)	Set of four bytes of address IPv4, from left to right	4
MAC-address	In every register – one byte (0 – 255)	Set of six bytes of address MAC-48, from left to right	6

Parameter Groups Available via MODBUS Protocol

Group	Description	Access	Address
Device description	Parameters are listed in Device Describing Parameters table	Any mode, only reading	0 – 3
Current mode	Parameters are listed in Current Mode Parameters table. Password entry is available in any mode, command entry - only in setup mode (after password entry)	Depending on the mode	100 – 120
Current status	Parameters are listed in Current Status Parameters table	Any mode, only reading	121 – 295, 900 – 944, 5000 – 5249

Group	Description	Access	Address
Changeable settings	The parameters listed in Settings Parameters table that can be changed and activated	Only in mode of setting, for reading or writing	300 – 829, 5250 – 5499
Active settings	The settings being used by the device at the moment	In any mode, only reading	2300 – 2829, 5500 – 5749
Saved settings	The set is saved regardless the power of the EM-486 and is used at starting of the device	Only in mode of setting, only reading	3300 – 3829, 5750 – 5999
Clock setting	See Clock Setting Parameters table	Only in clock setting mode, for reading or writing	34817 – 34825

Device Describing Parameters

Parameter	Description	Address
Type of device	The code defining the instrument MODBUS at the manufacturer (15 – EM-486)	0
Program version	Program version of integrated firmware of the device	1
Control code	CRC32 of the device program integrated firmware	2 – 3

Current Mode Parameters

Parameter	Range of Values	Initial Value	Description	Address
Password enter	Line of symbols	0	At entering the actual password, the client receives the appropriate access (see the registers 710-749). At entering the empty line, the rights of client are reset to level at the moment of connection	100 – 119
Command of control	0 – 40959, Writing in mode of setting	0	See Control Commands table	120

Control Commands (Register 120)

Value	Command	Description
0	No activity	-
1	Restart	Restart of the device

Value	Command	Description
2	Save	Save the changes of settings via MODBUS
3	Apply	Apply the settings without restart (It is only available for MODBUS, relays, transducers and user parameters)
4	Save and apply	Similarly to commands 2 and 3
6	Export	Read the saved settings and write them to a file on the memory card (see Appendix E)
7	Import	Read settings from a file on a memory card and save them
9	Cancel	To read the saved settings
21	Deactivate relay K1	Switch the relay K1 in normal state until the next command on relay or until reset of the device
22	Deactivate relay K2	See command 21
23	Deactivate relay K3	See command 21
29	Deactivate all relays	Switch all relays in normal state until the next command on relays or until reset of the device
31	Activate relay K1	Switch relay K1 in active state until the next command on relay or until reset of the device
32	Activate relay K2	See command 31
33	Activate relay K3	See command 31
39	Activate all relays	Switch all relays in active state until the next command on relay or until reset of the device
41	Control of relay K1	Switch relay K1 to automatic control (normal state before the events which are programmed for switching this relay) until the next command on relay or until reset of the device
42	Control of relay K2	See command 41
43	Control of relay K3	See command 41
49	Control of all relays	Switch all relays to automatic control (normal state before the events which are programmed for switching these relays) until the next command on relay or until reset of the device
51	Apply for MODBUS	Apply the settings via MODBUS and RS-485
54	Apply for input	Apply the settings at inputs sensors

Value	Command	Description
55	Apply for output	Apply the settings at the output of loading relays
59	Apply for user	Apply the settings for the user area of registers
61	Reset saved pulse counter at input 1	Before sending this command, you should open the access to change the saved counters (see command 13785)
62	Reset saved pulse counter at input 2	See 61
63	Reset saved pulse counter at input 3	See 61
64	Reset saved pulse counter at input 4	See 61
81	Synchronize clock with NTC server	-
82	Obtain account balance from GSM operator	-
161	Test SMS	Send a SMS test to the number of the main subscriber
10637	Back to Factory Settings	Reset the settings to the factory settings
13785	Start changing the stored pulse counters	It should be sent every time before usage of commands 61 – 64
35381	Start setting the clock	It allows access to the registers of clock setting 61 – 64
35431	Cancel setting the clock	It allows access to the registers of clock setting
40959	Clear the internal memory of the tasks	To erase the program for logic of actions (when the memory card is inserted, it will automatically read again)

Current Status Parameters

Parameter	Description	Address
Mode (see details for reg. 122)	0: User's mode; 1: Mode of setting	121
Tabs of access	See Access Flags table below	122
Time, min	Number of minutes since the moment of start-up	123 – 124

Parameter	Description	Address
Number of MODBUS TCP clients	Number of occupied connections of MODBUS TCP	125
Limit of MODBUS TCP clients	Total number of possible connections via MODBUS TCP	126
Load of RS-485, inquiries/s	Number of inquiries sent via RS-485 per second	127
Working load of RS-485, inquiries/s	Number of replies without errors via RS-485 per second	128
Load of RS-485 per second, %	Loading of RS-485 for the last second, with taking into account set rate of RS-485 and time of inactivity	129
Load of RS-485 per minute, %	Loading of RS-485 for the last minute	130
Load of RS-485 per 5 minutes, %	Loading of RS-485 for the last five minutes	131
Load of MODBUS TCP, inquiries/s	Number of inquiries received from the clients via MODBUS TCP per second	132
Useful load of MODBUS TCP, inquiries/s	Number of replies without errors being sent to the clients via MODBUS TCP per second	133
Load of GSM, kB/s	Wireless channel load channel with GSM being switched on	134
Load of Ethernet, ×100 kB/s	Loading of wire channel with Ethernet being switched on	135
Max. clients of MODBUS TCP	Maximal number of simultaneously connected clients via MODBUS TCP – from the moment of start up	136
Max. load of MODBUS TCP, inquiries/s	Maximal number of inquiries received per second from the clients via MODBUS TCP – from the moment of start up	137
Max. load of RS-485, %	Maximal loading of RS-485 for 5 minutes – from the moment of start up	138
Max. load of GSM, kB/s	Maximal loading of GPRS – from the moment of start up	139
Current IP-address of Ethernet	IP-address, by which the device is available in Ethernet network	140 – 143
Current MAC-address of Ethernet	MAC-address, by which the device is detected in Ethernet network	144 – 149
State of universal input 1	The readings of gauge connected to input 1, depending on the type of gauge (see register 580): for the gauges with analogue output – the value of gauge	150

Parameter	Description	Address
	output in mV or in μA (depending on the type of gauge); for discrete breakers – 0 at open contacts, 1 at closed contacts; for temperature gauges – the measured value of temperature, 32767 – at gauge cut off, -32768 – at gauge short circuit	
The effective value of input 1 state	The gauge readings at the input 1 given as to the user scale, in accordance to the settings (see registers 766 – 767)	151
State of universal input 2	The readings of the gauge connected to input 2	152
The effective value of input 2 state	The gauge readings at the input 2 given as to the user scale, in accordance to the settings	153
State of universal input 3	The readings of the gauge connected to input 3	154
The effective value of input 3 state	The gauge readings at the input 3 given as to the user scale, in accordance to the settings	155
State of universal input 4	The readings of the gauge connected to input 4	156
The effective value of input 4 state	The gauge readings at the input 4 given as to the user scale, in accordance to the settings	157
State of relay output 1	0 – relay off, 1 – relay on	160
State of relay output 2	0 – relay off, 1 – relay on	161
State of relay output 3	0 – relay off, 1 – relay on	162
Time before connection to remote server, s	0: there is a connection to server of data accumulation; 1: The connection is being made to the server of data accumulation; 2 – 65534: number of seconds before the repeated connection; 65535: connection to server is not used	165
Number of planned restarts	Number of restarts in accordance to the user setting – for total operational time of the device	166
Number of critical errors	Number of noted errors (failures) causing the restart of the device – for total operational time of the device	167
Operation time of device, min	Number of minutes of device operation – for total operational time of the device	168 – 169
Current time, s	Number of seconds since 1st of January of specified year (see reg. 172)	170 – 171
Year of time count	Year, since 1st of January which is taken for time count	172
Time zone, min	Time zone, for the time count, number of minutes with sign as to UTC+00	173
Temperature, °C	Device internal temperature	174

Parameter	Description	Address
Power voltage, mV	Bus voltage 12 V (voltage at the output of the internal power source or at inlet of backup power, depending on which the voltage is higher)	175
Time before connection to the first remote server MODBUS TCP	0 – there is a connection to remote server; 1 – the connection is being made to remote server; 2 – 65534: number of seconds before the repeated connection; 65535: connection to server is not used	176
Interface connection to the first remote server MODBUS TCP	0 – there is no connection; 1 – there is a connection by Ethernet; 2 – there is a connection to GPRS	177
Adding daylight saving time, min	Current adding daylight saving time	178
Relay control state	See Relay Control State Flags table	179
Pulse counter at input 1	Number of pulses at input 1 after starting	200 – 201
Pulse counter at input 2	Number of pulses at input 2 after starting	202 – 203
Pulse counter at input 3	Number of pulses at input 3 after starting	204 – 205
Pulse counter at input 4	Number of pulses at input 4 after starting	206 – 207
Year (current time)	Current year	210
Month (current time)	Current month	211
Day of the month (current time)	Current day of the month	212
Hour (current time)	Current hour	213
Minute (current time)	Current minute	214
Second (current time)	Current second	215
Day of week (current time)	Current day of week (1 – Monday)	216
Month (winter time)	Current month, excluding summer time	217
Day of the month (winter time)	Current day of the month, excluding summer time	218

Parameter	Description	Address
Hour (winter time)	Current hour, excluding summer time	219
Filter of the value of input 1	Last change of register 150 with a delay of 5 seconds	220
Filter of the reduced value of input 1	Last change of register 151 with a delay of 5 seconds	221
Filter of the value of input 2	Last change of register 152 with a delay of 5 seconds	222
Filter of the reduced value of input 2	Last change of register 153 with a delay of 5 seconds	223
Filter of the value of input 3	Last change of register 154 with a delay of 5 seconds	224
Filter of the reduced value of input 3	Last change of register 155 with a delay of 5 seconds	225
Filter of the value of input 4	Last change of register 156 with a delay of 5 seconds	226
Filter of the reduced value of input 4	Last change of register 157 with a delay of 5 seconds	227
The time of day, s	Number of seconds from midnight of the current day	230 – 231
The time of sunrise, s	0 – 86399: Number of seconds from midnight to sunrise; 86400: Sunrise is not observed in this day	232 – 233
The time of sunset, s	-1: Sunset is not observed in this day; 0 – 86399: Number of seconds from midnight to sunset	234 – 235
Time of day, ms	Number of ms from midnight of the current day	236 – 237
Memory card occupancy, 0.01%	10000 – memory card is missing or full	238
Estimated time spent on 1% of the memory card, days	0 – less than one day; 1 – 9999 – days for 1% of the memory card capacity; 10000 – more than 10000 days; 65535 – unknown	239
Time before connecting to the second remote MODBUS TCP server, s	0 – a connection to a remote server has been established; 1 – connecting to a remote server; 2 – 65534: number of seconds before reconnecting; 65535: Connection to MODBUS TCP server is not in use	240

Parameter	Description	Address
Interface for connecting to a second remote MODBUS TCP server	0 – connection not established; 1 – an Ethernet connection is established; 2 – the GPRS connection is established	241
Connection time to the third remote MODBUS TCP server, s	0 – a connection to a remote server has been established; 1 – connecting to a remote server; 2 – 65534: number of seconds before reconnecting; 65535: Connection to MODBUS TCP server is not in use	242
Connection interface to a third remote MODBUS TCP server	0 – connection not established; 1 – an Ethernet connection is established; 2 – the GPRS connection is established	243
Stored pulse counter at input 1	The number of pulses at input 1 during the operation of the memory card	250 – 251
Stored pulse counter at input 2	The number of pulses at input 2 during the operation of the memory card	252 – 253
Stored pulse counter at input 3	The number of pulses at input 3 during the operation of the memory card	254 – 255
Stored pulse counter at input 4	The number of pulses at input 4 during the operation of the memory card	256 – 257
The stored pulse counter at input 1 (battery)	Number of pulses at input 1 during operation of built-in battery of the clock	270 – 271
The stored pulse counter at input 2 (battery)	Number of pulses at input 2 during operation of built-in battery of the clock	272 – 273
The stored pulse counter at input 3 (battery)	Number of pulses at input 3 during operation of built-in battery of the clock	274 – 275
The stored pulse counter at input 4 (battery)	Number of pulses at input 4 during operation of built-in battery of the clock	276 – 277
Operating time of the relay 1, sec (battery)	Time in seconds during which the relay 1 is turned on (during operation of the built-in battery)	280 – 281
Operating time of the relay 2, sec (battery)	Time in seconds during which the relay 2 is turned on (during operation of the built-in battery)	282 – 283
Operating time of the relay 3, sec (battery)	Time in seconds during which the relay 3 is turned on (during operation of the built-in battery)	284 – 285
Switching-off counter of relay 1 (battery)	Switching-off number of relay 1 (during operation of the battery)	290 – 291

Parameter	Description	Address
Switching-off counter of relay 2 (battery)	Switching-off number of relay 2 (during operation of the battery)	292 – 293
Switching-off counter of relay 3 (battery)	Switching-off number of relay 3 (during operation of the battery)	294 – 295
Current IP-address of GSM	IP-address obtained from GSM provider	900 – 903
GSM signal level, %	Signal level and quality of radio communication with GSM provider	915
The type of battery connection	Type of hardware connection of the built-in battery power (battery for real time clock): 0 – the battery powers the clock in the central controller - memory of statistics (registers 270 – 299, 5240 – 5249); 1 – the battery powers the clock in GSM module, the memory of statistics is reset to zero when power is off	927
SIM card account status	The account status received for the last USSD query (sent automatically once a day); the first number in the operator's response is taken as an account. -2147483648 – account status is unknown	932 – 933
Time for receiving the SIM card account status value	Number of seconds since January 1 of specified year (see reg. 172). 0 – account status was not received	934 – 935
Memory card capacity, kB	0 - no card or unformatted in FAT / FAT32	941 – 942
The amount of data that has not been written to the memory card since the start, bytes	0 - there was no data record losses; 4294967295 - more than 4 GB losses	943 – 944
User parameters of status	User parameters of status after starting take a value of 0. They can be used for storage and transmission to the server of tasks of values to be measured and calculated in the files, and noted events	5000 – 5239
User parameters of statistics (battery)	They store the value for the operating time of the built-in battery for the clock. They can be used in the task files for statistics gathering or saving state	5240 – 5249

Access Flags (Register 122)

Bit	Description
0	Possibility for the connected client to obtain permission (using a password) for requests for the functions of reading devices via RS-485: 0 - permission cannot be obtained; 1 - permission can be obtained by password

Bit	Description
1	Allowing the connected client to request functions of reading devices via RS-485: 0 - no permission; 1 - permission is available
2	The ability for the connected client to obtain permission (using a password) to request recording functions and control devices via RS-485: 0 - permission cannot be obtained; 1 - permission can be obtained by password
3	Allowing the connected client to request recording and device control functions via RS-485: 0 - no permission; 1 - permission is available
4	The ability for the connected client to obtain permission (using a password) to access the EM-486 registers, except for the version registers, password, mode and access flags: 0 - permission cannot be obtained; 1 - permission can be obtained by password
5	The ability for the connected client to obtain permission (using a password) to access the EM-486 registers, except for the version registers, password, mode and access flags: 0 - permission cannot be obtained; 1 - permission can be obtained by password
7	Permission to the connected client to configure EM-486 (similar to register 121): 0 - no permission; 1 - permission is available
9	Client has an authority for connection (always is read as «1» after connection)
12	Allowing the connected client to set the clock: 0 - no permission; 1 - permission is available

Relay Control State Flags (Register 179)

Bit	Description
0	Indication of relay K1 ON (independent of reg. 575)
1	Indication of relay K2 ON (independent of reg. 576)
2	Indication of relay K3 ON (independent of reg. 577)
4	0 - Relay K1 in automatic mode (bit 12); 1 - Relay K1 in manual mode (depends on bit 8)
5	0 - Relay K2 in automatic mode (bit 13); 1 - Relay K2 in manual mode (depends on bit 9)
6	0 - Relay K3 in automatic mode (bit 14); 1 - Relay K3 in manual mode (depends on bit 10)
8	Manual command for K1 relay to switch on
9	Manual command for K2 relay to switch on
10	Manual command for K3 relay to switch on
12	Automatic command for K1 relay to switch on
13	Automatic command for K2 relay to switch on

Bit	Description
14	Automatic command for K3 relay to switch on

Device Settings Parameters

Ethernet Network

Parameter	Range of Values	Factory Value	Description	Address
Static IP-address	IP-address	192.168.0.111	If dynamic addressing is disabled or not available, the value of the IP address in the Ethernet	300 – 303
Sub network mask	IP-mask	255.255.255.0	It is used only with a static IP-address	304 – 307
Gateway	IP-address	192.168.0.1	It is used only with a static IP-address, or as IP filter for DHCP-server	308 – 311
Switch on the dynamic addressing with a help of DHCP	0 – 1	1	0: preset IP-address, mask and gateway is used for addressing in Ethernet. 1: If the DHCP server is available in the network, then the IP address, mask and gateway are received from the server	312
Switch on the filter of IP-address of DHCP-server	0 – 1	0	Used if dynamic addressing is enabled. 0: device receives addressing data from the first DHCP-server to respond; 1: device receives addressing data only from DHCP-server with IP-address of the gateway	313
Switch on the use of server DNS of gateway	0 – 1	1	It is used if DHCP is not available (switched off). 0: DNS of gateway is not used; 1: To determine the IP addresses of other servers, if they are specified by host names	314
IP-address of the first DNS server	IP-address	8.8.8.8	Used if DHCP is not available (disabled). 0.0.0.0 - not used	315 – 318
Second DNS server IP address	IP-address	0.0.0.0	It is used if DHCP is not available (switched off). 0.0.0.0 – not used	319 – 322
Enable MAC address override	0 – 1	0	0: unique value for every device, stored in the memory shall be used as a MAC-address; 1: manually set MAC-address is used	323
Manually specified MAC-address of Ethernet	MAC-address	Unique for each device	Used if manually set MAC-address is enabled for the authentication of device in the Ethernet network Ethernet	324 – 329

GSM Network

Parameter	Range of Values	Factory Value	Description	Address
Pin code of SIM-card	0 – 65535	65535	0 – 9999: this code is used for the SIM card if it demands the PIN code. Other values: the code isn't used, SIM card and GSM are unavailable if the card demand a code	330
Switch on the automatic definition of APN and USSD query of GSM operator	0 – 1	1	0: device makes GPRS connection by manually set APN parameters, to receive the status of the account, a USSD query is sent manually; 1: APN and USSD account status query are automatically determined for the operator according to ICCID code of SIM card	331
Activate GPRS in roaming	0 – 1	1	0: GPRS is blocked in roaming; 1: GPRS may be used in roaming	332
Activate SMS messages sending in roaming	0 – 1	0	0: SMS messages cannot be sent (but can be received) in roaming; 1: SMS messages can be received and sent in roaming	333
MODBUS TCP connection port via GSM	0 – 65535	0	It is used for external connection to the device via GSM with static IP, for exchange using MODBUS TCP protocol. 0 – It is disabled	334
USSD query to receive an account	Line of symbols	-	It is provided by GSM service provider; up to 12 characters. There cannot be any spaces in a string	340 – 351
APN log-in of GPRS service	Line of symbols	-	Specified by provider of GSM service. Up to 40 symbols	352 – 391
APN password of GPRS service	Line of symbols	-	Specified by provider of GSM service. Up to 24 symbols	392 – 415
APN address of host	Line of symbols	-	Specified by provider of GSM service. Up to 34 symbols. In line there should not be any spaces	416 – 449

MODBUS TCP Clients

Parameter	Range of Values	Factory Value	Description	Address
Connection port via MODBUS TCP	1 – 65535	502	Used at external connection to the device for exchange via MODBUS TCP protocol	450
Disable inactive clients	0 – 1	1	0 - MODBUS TCP connection is supported regardless of the time between requests from the client; 1 -	451

Parameter	Range of Values	Factory Value	Description	Address
			disconnect clients that have not received requests for longer than a specified time	
Max. reply waiting time, s	0 – 600000	90	Used if disable inactive clients is selected	452 – 453
Enable the order for the last made connection via MODBUS TCP	0 – 1	0	0: connection via MODBUS TCP is supported regardless of connection holding time; 1: If all connections via MODBUS TCP are used, a new client inquiring for connection can be connected instead of the last connected client, if the time of connection holding on is more than the specified time	454
Max. time of last connection holding via MODBUS TCP, ms	0 – 600000	60000	Used if the order for the last connection via MODBUS TCP is enabled	455 – 456

MODBUS Network

Parameter	Range of Values	Factory Value	Description	Address
Native MODBUS-identifier of the device	0 – 247	111	0: device forwards all MODBUS TCP requests into the MODBUS network, device registers via MODBUS TCP are unavailable; 1–247: devices respond to MODBUS TCP requests bearing the given MODBUS-identifier without forwarding them to the MODBUS network	457
Bit rate via RS-485, bit/sec	75 – 921600	9600	Used in case of data exchange between the devices via RS-485, the same value for the devices on the same bus-bar	458 – 459
Activate selection of byte format when transmitting via RS-485	0 – 1	1	Used in case of data exchange between the devices via RS-485, the same value for all devices on the same bus-bar. 0: unused, byte is completed with 2 stop bits; 1: Byte format is selected in register 461	460
Byte format when transmitting via RS-485	0 – 5	5	Is used for exchange with devices via RS-485 only if byte format selection is activated. The value for devices on the same bus-bar. 0: even ("EVEN") – 1 parity bit and 1 stop bit; 1: odd ("ODD") – 1 parity bit and 1 stop bit; 2: «0» ("SPACE") – 1 zero bit and 1 stop bit; 3: «1» ("MARK") – 1 device bit and 1 stop bit (similar to mode with two stop-	461

Parameter	Range of Values	Factory Value	Description	Address
			bits); 4: "ABSENT" – no parity bit, 1 stop bit; 5: "AUTO-STOP" – no parity bit, 2 stop bits in the outgoing bytes, 1 stop bit in the incoming bytes; in such a case, devices with one and two stop bits may be connected simultaneously	
Response time from MODBUS RTU, ms	0 – 60000	200	Used in case of data transfer via RS-485 in RTU mode. Waiting for a response is terminated if the first byte of the response has not been received within the given time after sending the request. The response is always expected longer than time of silence between frames (time of silence depends on the bit rate and shall be equal to the time required for transmitting 3.5 bytes, or 1.75 msec for bit rate over 19200 bits/sec)	462
Enable ASCII exchange via RS-485	0 – 1	0	Exchange mode via RS-485, the same value for all devices on the same bus-bar. 0: RTU exchange mode (format: 1start bit, 8 data bits, 2 stop-bits, parity bit, and stop bit or only 1 stop bit – total from 10 to 11 bits); 1: ASCII exchange mode (format: 1start bit, 7 data bits, 2 stop-bits or parity bit or stop bit – total 10 bits). The non-standard byte forms 4 (register 461, values 4 and 5) are not accessible; format 3 (2 stop bits) is used instead	463
Response time for subsequent MODBUS ASCII character, ms	0 – 60000	1000	Used in case of data transfer via RS-485 in ASCII mode. Waiting for a response is terminated if the subsequent byte of the response has not been received within the given time, as indicated for the reception of response. Waiting time shall not be less than time required for transmission of a single character (depending on the bit rate)	464

Connection to Data Accumulation Server

Parameter	Range of Values	Factory Value	Description	Address
Mode of connection to the server for data accumulation	0 – 4	1	0: connection to server is not used; 1: the device makes and holds the connection to the server via the specified connection port (port on the North side); 2: passive mode, waiting for a connection from the server through the specified server connection port (port on the EM-486 side); 3: similar 1, but only via Ethernet; 4: similar 1, but only via GPRS	465

Parameter	Range of Values	Factory Value	Description	Address
Server connection port	0 – 65535	20502	Inquiry port to which is addressed a side making a connection between a device and a server (see reg. 465)	466
Time of waiting for a reply from the server, sec	0 – 3600	120	0: the server silence time is not limited; 1–3600: max. time of server silence after which the connection will be broken and must be remade again	467
Time of waiting before the second connection to the server, s	0 – 30000	15	Connection to the server of data accumulating (used in except the mode «2»). After the connection with the server is lost, the reconnection will be made after a specified waiting time (after starting the device, the first connection is made after a fixed time - 5 s)	468
Enable the server address by a text line	0 – 1	1	Used in connection to accumulating server (in except the mode «2»). 0: the connection is made to the server with a fixed IP-address set in the registers 470 – 473; 1: connection is made to the server with a name set in the registers 474 – 509	469
Data collection server IP address	IP-address	0.0.0.0	Used in connection to the server (in except the mode «2») if the setting of server address is not activated by a text line. IP-address of remote server which supports the connection	470 – 473
Data collection server address	Symbols line	modbus.overvis.com	Used in connection to the server (in except the mode «2») if the setting of server address is activated by a text line. Remote server address which supports the connection. As an address there can be a line with length up to 36 symbols. There should be no spaces in the line	474 – 509

Security

Parameter	Range of Values	Factory Value	Description	Address
Specified password for access to the mode of setting	Line of symbols	11111	Used for access to the mode of setting EM-486. As a password there can be used a line with length from 5 to 10 symbols. There should be no spaces in the line	510 – 519
Specified password for writing access via incoming SMS	Line of symbols	gap	Used for verification of incoming SMS with inquiry for writing of alarm confirmation. As a password there can be used a line with length from 3 to 10 symbols. There should be no spaces in the line	530 – 539
Specified password for reading access via incoming SMS	Line of symbols	gap	Used for verification of incoming SMS with inquiry for reading of alarm confirmation. As a password there can be used a line with length from 3 to 10 symbols. There should be no spaces in the line	540 – 549
Specified password for writing access via MODBUS TCP in devices (in except the EM-486)	Line of symbols	-	Used for access to the devices connected to EM-486, for inquiry of functions of writing or control, that can change the state of these devices. As a password there can be used a line with length up to 10 symbols. There should be no spaces in the line	550 – 559
Specified password for reading access via MODBUS	Line of symbols	-	Used for access to the devices connected to EM-486, for inquiry of functions of reading or for access to registers of EM-486 except for registers of version, password, mode and tags. As a password there can be used a line with length up to 10 symbols. There should be no spaces in the line	560 – 569
Enable the protection mode against writing via SMS	0 – 1	0	0: protection against writing is regulated with help of other parameters (password); 1: blocking of inquiries via SMS for function of writing	570
Enable the protection mode against reading via SMS	0 – 1	0	0: protection against reading is regulated with help of other parameters (password); 1: blocking of inquiries via SMS for function of reading	571
Enable the protection mode against writing via MODBUS TCP	0 – 1	0	0: protection against writing is regulated with help of other parameters (password) or deactivated; 1: blocking of any function inquiries except for functions of MODBUS 1, 2, 3, 4, 7, 17, 20	572
Enable the protection mode against reading via MODBUS TCP	0 – 1	0	0: protection against reading is regulated with help of other parameters (password) or deactivated; 1: blocking of inquiries for MODBUS functions 1, 2, 3, 4, 7, 17, 20, except for reading of functions of three registers of version, mode and tabs	573

Relay

Parameter	Range of Values	Factory Value	Description	Address
Normal state of relay K1	0 – 1	0	0 – in normal state the relay is OFF; 1 – in normal state the relay is ON, a command for switching on the relay, deactivates it	575
Normal state of relay K2	0 – 1	0	0 – in normal state the relay is OFF; 1 – in normal state the relay is ON, a command for switching on the relay, deactivates it	576
Normal state of relay K3	0 – 1	0	0 – in normal state the relay is OFF; 1 – in normal state the relay is ON, a command for switching on the relay, deactivates it	577

Sensors

Parameter	Range of Values	Factory Value	Description	Address
Type of sensor connected to input 1	0 – 17	0	0: Sensor is not connected; 1: Sensor with output 0 – 10 V; 2: Sensor with output 2 – 10 V; 3: Sensor with output 0 – 20 mA; 4: Sensor with output 4 – 20 mA; 5: Discrete breaker; 6: Temperature NTC 2 kΩ (B=3950); 7: Temperature NTC 2.5 kΩ (B=3660); 8: Temperature NTC 2.5 kΩ (B=3980); 9: Temperature NTC 5 kΩ (B=3300); 10: Temperature NTC 5 kΩ (B=3520); 11: Temperature NTC 5 kΩ (B=3970); 12: Temperature NTC 6.8 kΩ (B=3520); 13: Temperature NTC 10 kΩ (B=3435); 14: Temperature NTC 10 kΩ (B=3650); 15: Temperature NTC 10 kΩ (B=3950); 16: Temperature NTC 15 kΩ (B=4145); 17: Temperature NTC 20 kΩ (B=4200)	580
Effective minimum value for sensor of input 1	-32768 – +32767	0	For the sensor with analog output – the value of register of effective value (address 141) at minimal value of sensor output (depending on the type); For the discrete breakers – the value of the register of effective value at contacts being open; For temperature sensors – the sensor temperature values (address 140), for which the correction is made	581
Effective maximum value for sensor of input 1	-32768 – +32767	100	For the sensor with analog output – the value of register of effective value (address 141) at maximal value of sensor output (depending on the type); For the discrete breakers – the value of the register of effective value at contacts being closed; For temperature sensors – sensor corrected	582

Parameter	Range of Values	Factory Value	Description	Address
			temperature value (address 141), at measured temperature equal to the value of register 581	
Presentation value of sensor 1	0 – 1	0	0: Measured value is presented on the display console and at the status page of WEB-interface; 1: Adjusted value is presented on the display console and at the status page of WEB-interface	583
Quantity of decimal signs of adjusted value of sensor 1	0 – 4	0	The parameter is not used if presentation of measured value has been selected. When adjusted value is presented on the display console or at the status page of WEB-interface, this parameter indicates accuracy of the decimal fraction (position of decimal point from the right edge)	584
Annexation of a measuring device of adjusted value of sensor 1	-24 – +24	0	The parameter is not used if presentation of measured value has been selected. When adjusted value is presented on the display console or at the status page of WEB-interface, a corresponding annex is presented after the value (0 – no annex): -24: «i»; -21: «z»; -18: «a»; -15: «f»; -12: «p»; -9: «n»; -6: «μ»; -3: «m»; -2: «s»; -1 «d»; 1: «yes»; 2: «g»; 3: «k»; 6: «M»; 9: «G»; 12: «T»; 15: «P»; 18: «E»; 21: «Z»; 24: «l»	585
Measuring device of effective value of sensor 1 for imaging	Line of symbols	%	The parameter is not used if presentation of measured value has been selected. When adjusted value is presented on the display console or at the status page of WEB-interface, the value a corresponding is presented after annex.	586 – 589
Type of sensor connected to input 2	0 – 17	0	Similar to 580	590
Effective minimum value for sensor of input 2	-32768 – +32767	0	Similar to 581	591
Effective maximum value for sensor of input 2	-32768 – +32767	100	Similar to 582	592



Parameter	Range of Values	Factory Value	Description	Address
Presentation value of sensor 2	0 – 1	0	Similar to 583	593
Quantity of decimal signs of adjusted value of sensor 2	0 – 4	0	Similar to 584	594
Annexation of a measuring device of adjusted value of sensor 2	-24 – +24	0	Similar to 585	595
Measuring device of effective value of sensor 2 for imaging	Line of symbols	%	Similar to 586 – 589	596 – 599
Type of sensor connected to input 3	0 – 17	0	Similar to 580	600
Effective minimum value for sensor of input 3	-32768 – +32767	0	Similar to 581	601
Effective maximum value for sensor of input 3	-32768 – +32767	100	Similar to 582	602
Presentation value of sensor 3	0 – 1	0	Similar to 583	603
Quantity of decimal signs of adjusted value of sensor 3	0 – 4	0	Similar to 584	604

Parameter	Range of Values	Factory Value	Description	Address
Annexation of a measuring device of adjusted value of sensor 3	-24 – +24	0	Similar to 585	605
Measuring device of effective value of sensor 3 for imaging	Line of symbols	%	Similar to 586 – 589	606 – 609
Type of sensor connected to input 4	0 – 17	0	Similar to 580	610
Effective minimum value for sensor of input 4	-32768 – +32767	0	Similar to 581	611
Effective maximum value for sensor of input 4	-32768 – +32767	100	Similar to 582	612
Presentation value of sensor 4	0 – 1	0	Similar to 583	613
Quantity of decimal signs of adjusted value of sensor 4	0 – 4	0	Similar to 584	614
Annexation of a measuring device of adjusted value of sensor 4	-24 – +24	0	Similar to 585	615
Measuring device of effective value	Line of symbols	%	Similar to 586–589	616 – 619

Parameter	Range of Values	Factory Value	Description	Address
of sensor 4 for imaging				

Miscellaneous

Parameter	Range of Values	Factory Value	Description	Address
Enable periodic automatic restart of the device	0 – 1	1	0: periodic restart disabled; 1: device restarts at a specified interval of time	630
Device restart interval, min	5 – 7200	120	Used if periodic restart of the device is enabled	631
Enable the mode of automatic restart only when there are no connections	0 – 1	1	Used if periodic automatic restart of the device is enabled. 0: device restarts at a specified interval of time after startup; 1: device restarts at a specified interval of time after the last transmitting via Ethernet or GSM networks	632
MODBUS exception code generated when there is no access	0 – 255	1	0: When there is no access to device MODBUS registers or connected devices, the reply is not returned to the client. 1-255: When there is no access to the client sending the inquiry, this exception code is returned	633
MODBUS exception code generated when there is no reply	0 – 255	11	0: When there is no reply from inquiry addressee (Gateway Timeout) the reply is not returned to the client; 1-255: when there is a reply from the inquiry addressee, this exception code is returned to the client	634
Switch on normally closed relays only after device complete initialization	0 – 1	0	0: normally closed relays are switched on immediately after device start; 1: normally closed relays are switched on only after device initialization procedure (it is recommended, if relay outputs are connected with universal inputs)	635
MODBUS exception code generated if there is no connection to query addressee	0 – 255	10	0 – If there is no connection to the query addressee (Gateway Path Unavailable), response is not returned to the client; 1 – 255 – if there is no connection to the query addressee, this exception code is returned to the client	636

Parameter	Range of Values	Factory Value	Description	Address
Enable RS-485 slave mode	0 – 1	0	0 – Driving mode (Master). RS-485 is used to send queries; 1 – Driven mode (Slave). RS-485 is used to receive queries from additional client	637
First MODBUS-identifier of RS-485	1 – 255	1	Parameters define a range of MODBUS identifiers used for RS-485. In the master mode the queries with addresses in this range (and also the broadcast ones with address 0) are sent via RS-485. In the slave mode the queries with addresses in this range (and also the broadcast ones and the queries to EM-486 address) are received via RS-485	638
Last MODBUS-identifier of RS-485	1 – 255	255	See register 638	639

Connection to the First Remote Server of MODBUS TCP

Parameter	Range of Values	Factory Value	Description	Address
IP-address of remote server	IP-address	192.168.0.112	It is used when enabling redirection of queries to MODBUS TCP remote server. IP-address of the remote server wherewith connection is maintained	640 – 643
Port of the remote server connection	0 – 65535	502	It is used during redirection of queries to the remote server. The remote server port is for MODBUS TCP connection	644
Standby time to answer from the remote server, ms	0 – 60000	1000	It is used during redirection of queries to the remote server. After the query transfer, if the correct answer failed to be received within this time interval, answer waiting is stopped	645
Standby time to repeated connection to the remote server, ms	0 – 240	20	It is used during redirection of queries to the remote server. After connection with the server is lost, the repeated connection will be performed after preset standby time	646
Remote server connection mode	0 – 8	0	0 – MODBUS TCP remote server is not used; 1 – to connect to the server using Ethernet or GPRS, preferably via Ethernet; 2 – to connect to the server using Ethernet or GPRS, preferably via GPRS; 3 – to connect to the server only via Ethernet; 4 – to	647

Parameter	Range of Values	Factory Value	Description	Address
			connect to the server only via GPRS; 5 – similar to 1 with virtual identifiers; 6 – similar to 2 with virtual identifiers; 7 – similar to 3 with virtual identifiers; 8 – similar to 4 with virtual identifiers	
First MODBUS-identifier of the remote server	1 – 255	1	It is used during redirection of queries to the remote server. The parameters define the range of MODBUS identifiers used on the remote server. Queries with addresses in this range (and also the broadcast ones with address 0) are sent to the remote MODBUS TCP server	648
Last MODBUS-identifier of the remote server	1 – 255	255	See register 648	649

Counters

Parameter	Range of Values	Factory Value	Description	Address
Pulse counter mode for input 1	0 – 7	0	0 - counter not used; 1 - pulse rising edge counter; 2 - pulse falling edge counter; 3 - both pulse edges counter; 4 - similar to 0; 5 - similar to 1, the counter is saved to the memory card; 6 - similar to 2, the counter is saved to the memory card; 7 - similar to 3, the counter is saved to the memory card	650
Pulse quantity in device of time of counter 1	1 – 999999999	8000	Used only is counter is switched on. Pulse quantity on input, after pulses are registered counter is set to one	651 – 652
Counter 1 maximum value	0 – 999999999	999999999	Used only is counter is switched on. After counter maximum value exceeds counter is set to 0	653 – 654
Counter 1 maximum frequency	1 – 500000	500000	Used only is counter is switched on. Square pulses maximum frequency on input. For pulses of other form value shall be increased	655 – 656
Lower threshold for determining the edge of the pulse for counter 1	0 – 100	25	Used only is counter is switched on. Falling edge start is defined when signal weakens on input at lower threshold. Threshold is set as a share from peak signal in percentages	657

Parameter	Range of Values	Factory Value	Description	Address
Upper threshold for determining the leading edge for counter 1	0 – 100	75	Used only is counter is switched on. Rising edge start is defined when signal enhances on input at higher threshold. Threshold is set as a share from peak signal in percentages	658
Pulse counter mode for input 2	0 – 7	0	Similarly 650	660
Pulse quantity in device of time of counter 2	1 – 999999999	8000	Similarly 651 – 652	661 – 662
Counter 2 maximum value	0 – 999999999	999999999	Similarly 653 – 654	663 – 664
Counter 2 maximum frequency	1 – 500000	500000	Similarly 655 – 656	665 – 666
Lower threshold for determining the edge of the pulse for counter 2	0 – 100	25	Similarly 657	667
Upper threshold for determining the leading edge for counter 2	0 – 100	75	Similarly 658	668
Pulse counter mode for input 3	0 – 7	0	Similarly 650	670
Pulse quantity in device of time of counter 3	1 – 999999999	8000	Similarly 651–652	671 – 672
Counter 3 maximum value	0 – 999999999	999999999	Similarly 653–654	673 – 674
Counter 3 maximum frequency	1 – 500000	500000	Similarly 655–656	675 – 676
Lower threshold for determining the edge of the	0 – 100	25	Similarly 657	677

Parameter	Range of Values	Factory Value	Description	Address
pulse for counter 3				
Upper threshold for determining the leading edge for counter 3	0 – 100	75	Similarly 658	678
Pulse counter mode for input 4	0 – 3	0	Similarly 650	680
Pulse quantity in device of time of counter 4	1 – 999999999	8000	Similarly 651–652	681 – 682
Counter 4 maximum value	0 – 999999999	999999999	Similarly 653–654	683 – 684
Counter 4 maximum frequency	1 – 500000	500000	Similarly 655–656	685 – 686
Lower threshold for determining the edge of the pulse for counter 4	0 – 100	25	Similarly 657	687
Upper threshold for determining the leading edge for counter 4	0 – 100	75	Similarly 658	688

Automatic Transition to Daylight Saving Time

Parameter	Range of Values	Factory Value	Description	Address
Daylight saving time transition mode	0 – 15	0	0 – automatic transition is not used (the gain can be set manually when setting the clock); 1 – Brazil; 2 – Great Britain; 3 – Germany; 4 – Greece; 5 – Jordan; 6 – Italy; 7 – Namibia; 8 – Poland; 9 – Portugal; 10 – USA; 11 – Turkey; 12 – Namibia; 13 – Finland; 14 – France; 15 – according to preset days	700

Parameter	Range of Values	Factory Value	Description	Address
Preset month for transition to daylight saving time	1 – 12	3	It is used if you selected the automatic transition to daylight saving time on the specified days. The month when the clock will be set one hour ahead	701
Preset week of the month for transition to daylight saving time	1 – 10	10	It is used if you selected the automatic transition to daylight saving time on the specified days. Week of the month when the clock will be set one hour ahead. 1–5 – week of the month, counting the part weeks; other values – the last week of the month	702
Preset the week day for transition to daylight saving time	1 – 7	7	It is used if you selected the automatic transition to daylight saving time on the specified days. The week day when the clock will be set one hour ahead	703
Preset hour for transition to daylight saving time	0 – 22	2	It is used if you selected the automatic transition to daylight saving time on the specified days. The hour of the day at which the clock will be set one hour ahead	704
Preset month of revert to standard time	1 – 12	10	It is used if you selected the automatic transition to daylight saving time on the specified days. The month when the clock will be set one hour back	705
Preset week of the month of revert to standard time	1 – 10	10	It is used if you selected the automatic transition to daylight saving time on the specified days. Week of the month when the clock will be set one hour back. 1–5 – week of the month, counting the part weeks; other values – the last week of the month	706
Preset day of the week of revert to standard time	1 – 7	7	It is used if you selected the automatic transition to daylight saving time on the specified days. The day of the week when the clock will be set one hour back	707
Preset hour of revert to standard time	1 – 23	3	It is used if you selected the automatic transition to daylight saving time on the specified days. The hour of the day at which the clock will be set one hour back	708

Calculation of Sunrises and Sunsets

Parameter	Range of Values	Factory Value	Description	Address
Sunny day	0 – 3	1	0 – official; 1 – civil; 2 – nautical; 3 – astronomical	709

Parameter	Range of Values	Factory Value	Description	Address
Latitude, degrees	0 – 89	46	The absolute value of the latitude	710
Latitude, minutes	0 – 59	29	Minutes of latitude	711
Latitude, seconds	0 – 59	10	Seconds of latitude	712
Longitude, degrees	0 – 179	30	The absolute value of the longitude	713
Longitude, minutes	0 – 59	43	Minutes of longitude	714
Longitude, seconds	0 – 59	40	Seconds of longitude	715
Quadrant	0 – 3	0	0 – N latitude, E longitude; 1 – N latitude, W longitude; 2 – S latitude, E longitude; 3 – S latitude, W longitude	716

The Connection to the Server of NTP Clock Synchronization

Parameter	Range of Values	Factory Value	Description	Address
NTP server connection mode	0 – 4	0	0 – clock synchronization with the server is not used; 1 – to connect to the servers using Ethernet or GPRS, preferably via Ethernet; 2 – to connect to the servers using Ethernet or GPRS, preferably via GPRS; 3 – to connect to the servers only via Ethernet; 4 – to connect to the servers only via GPRS	717
Time period of connection to NTP servers, h	1 – 240	24	It is used if you have enabled synchronization of clocks with the server clock. The time interval over which the server time is received	718
Minimum shift of clock for synchronization, s	1 – 180	2	It is used if you have enabled synchronization of clocks with the server clock. The synchronization is performed after receiving the server time, if the difference between the clocks is no less than this value	719

Logging

Parameter	Range of Values	Factory Value	Description	Address
Supply voltage minimum for safe memory card removal, mV	0 – 24000	9000	If the supply voltage is below the specified value, the memory card will be safely removed. The card can be used again after the supply voltage exceeds the minimum plus 0.5 V. 0 - do not remove the memory card, even if the supply voltage is unknown	724
Format for logging parameters in task files	0 – 4	1	Used if there is a memory card and logging actions in task files. 0 - not used; 1 - compact file of data bytes; 2 - CSV table with text separator; 3 - similarly 2 with a separator; 4 - similar to 2 with tab delimiter	725
Maximum size of log files, kB	0 – 65535	65535	Used if there is a memory card present, logging actions in task files, and logging is enabled. The size of the generated files is limited to the specified size plus 1 kB	726
Minimum stored period in recorder mode, days	0 – 255	30	Used if there is a memory card present, logging actions in task files, and logging is enabled. 0-183 - the oldest files (older than the specified number of days ago) can be deleted to write new data; Other values - old files are saved, new data recording is suspended when the memory card is full	727

Encryption

Parameter	Range of Values	Factory Value	Description	Address
Communication channel encryption with MODBUS TCP clients	0 – 2	1	Used for connections to MODBUS TCP ports (reg. 334 and 450). 0 - disabled; 1 - optional (enabled at the client's request, if the client supports encryption); 2 - forced (commands and data are blocked, except those necessary to start the encrypted channel)	728
MODBUS identifier of the first remote server compatible with Novatek-Electro gateways	0 – 255	0	Used only when connection to a remote server is selected. Virtual ID mode, if enabled for the server, is not reflected in this parameter. 0 - features for compatible gateways are disabled (recommended if compatibility is unknown); 1-255 - channel encryption (reg. 731), password sending for access (reg. 800-809) are available; if disabling of inactive clients (reg. 451) is selected, short requests are sent during downtime to maintain the connection	730

Parameter	Range of Values	Factory Value	Description	Address
Encryption of communication channel with the first remote MODBUS TCP server	0 – 2	1	Used only if connection to a remote server is selected and its identifier is set (reg. 730). 0 - disabled; 1 - optional (enabled if the server supports encryption); 2 - forced (the connection is disconnected if the encrypted channel could not be established)	731
MODBUS identifier of the second remote server	0 – 255	0	Similar to 730	732
Encryption of communication channel with the second remote server MODBUS TCP	0 – 2	1	Similar to 731	733
MODBUS identifier of the third remote server	0 – 255	0	Similar to 730	734
Encryption of communication channel with the third remote MODBUS TCP server	0 – 2	1	Similar to 731	735

Subscribers

Parameter	Range of Values	Factory Value	Description	Address
Main subscriber phone number	Character string	-	Can be used to send SMS. Up to 20 characters. There can be no spaces in the line	740 – 759

Connect to the Second Remote MODBUS TCP Server

Parameter	Range of Values	Factory Value	Description	Address
Remote server IP address	IP-address	192.168.0.113	Similar to 640 – 643	760 – 763
Remote server connection port	0 – 65535	502	Similar to 644	764

Parameter	Range of Values	Factory Value	Description	Address
Waiting time for a response from a remote server, ms	0 – 60000	1000	Similar to 645	765
Waiting time before reconnecting to a remote server, ms	0 – 240	20	Similar to 646	766
Remote server connection mode	0 – 8	0	Similar to 647	767
First MODBUS-identifier of the remote server	1 – 255	1	Similar to 648 – 649	768
Last MODBUS-identifier of the remote server	1 – 255	255	See register 768	769

Connection to the Third Remote MODBUS TCP Server

Parameter	Range of Values	Factory Value	Description	Address
IP address of the remote server	IP address	192.168.0.113	Similar to 640 – 643	770 – 773
Remote server connection port	0 – 65535	502	Similar to 644	774
Response time from remote server, ms	0 – 60000	1000	Similar to 645	775
Waiting time before reconnection to the remote server, ms	0 – 240	20	Similar to 646	776
Remote server connection mode	0 – 8	0	Similar to 647	777
First MODBUS-identifier of the remote server	1 – 255	1	Similar to 648– 649	778
Last MODBUS-identifier of the remote server	1 – 255	255	See register 778	779

Preset Passwords for Access to Remote Servers

Parameter	Range of Values	Factory Value	Description	Address
Preset password for access to the first remote MODBUS TCP server	Character string	-	Used only if connection to a remote server is selected and its ID is set (reg. 730). If a password is set, it will be entered immediately after connecting to the server. Obtained access rights depend on the settings of the remote server. A string up to 10 characters long	800 – 809

Parameter	Range of Values	Factory Value	Description	Address
			can be specified as a password. No spaces can be in the string	
Preset password for access to the second remote MODBUS TCP server	Character string	-	Similar to 800 – 809	810 – 819
Preset password for access to the third remote MODBUS TCP server	Character string	-	Similar to 800 – 809	820 – 829

User Settings

Parameter	Range of Values	Factory Value	Description	Address
User's settings and stored values	0 – 65535	0	They can be used to store any identification data of the device or for adjusting the settings of task files operation	5250 – 5499

Setting the Clock

Note

Registers for the clock setting are available only in the clock setting mode, see registers 120, 122.

Parameter	Range of Values	Factory Value	Description	Address
Adding daylight saving time, min	-1440 – +1440	-	Current gain. It is set during manual transition to the daylight saving time, when selecting the automatic mode it will be adjusted within 5 minutes. The value must be a multiple of 15	34817
Adding time zone, min	-1440 – +1440	120	It is used during synchronization of the clock with the server clock. The value must be a multiple of 15	34818
Second	0 – 59	-	The time is to be set at the clock	34819
Minute	0 – 59	-	The time is to be set at the clock	34820

Parameter	Range of Values	Factory Value	Description	Address
Hour	0 – 23	-	The time is to be set at the clock	34821
Day	1 – 31	-	The date is to be set at the clock	34822
Month	1 – 12	-	The date is to be set at the clock	34823
Year	0 – 65535	-	The year is to be set at the clock	34824
Set the clock	0 – 65535	0	It is used to set the clock. When recording to this register with any value, the new clock settings in registers 34817-34824 will be set	34825

Virtual Identifiers Mode

In the virtual identifier's mode, before the request is redirected to the remote server, the virtual identifier of the addressee from the request is replaced with the real one so that the numbering in the server range starts from 1. For example, for the range 15-17, the virtual ID 16 will be replaced with the real 2. Broadcast ID 0 is processed unchanged.

Appendix E: Saving Data to Memory Card

1. General Data

The EM-486 supports microSD compatible memory cards formatted in FAT/FAT32. Only the first volume of the card is used (the maximum usable capacity on the card is 32 GB). The card can be inserted before powering on the device or while the device is in operation.

Caution

Removing a memory card while the device is in operation may result in partial or complete loss of information on it. For safe removal of the memory card see section 5.3.1 of the manual.

EM-486 uses a memory card for the following actions:

- Reading task files with programmable logic of work
- Logging of collected data
- Export and import of settings
- Firmware updates
- Navigation on the memory card, downloading and uploading files through the WEB-interface

When the device is started or when a memory card is inserted, its parameters and firmware update files are checked (it may take up to 30 seconds). After that, the card can be used for other actions.

When the device is restarted, when the supply voltage drops below the value specified in the settings (see register 724 in Appendix D), EM-486 safely ejects the memory card, saving temporary data and closing open files.

2. Reading Task Files with Programmable Logic of Work

EM-486 reads task files from the "TASKS" folder and its subfolders on the memory card (see Appendix C - Task Files).

3. Logging of Collected Data

EM-486 saves the collected data to the log in the "LOGS\TASKS" folder on the memory card. The order of data collection and conditions for logging are specified in the task files (see Appendix C). If the folder is missing, it will be created.

For each month, a subfolder is created with a name in the format:

YYYY_MM

Where:

- YYYY – year
- MM – month

In this subfolder, for each day of the month, a file is created with the name in the format:

YYMMDDII.EEE

Where:

- YY – the last two digits of the year
- MM – month
- DD – day of the month
- II – index. The data is appended to the end of the current file. A new file with the next index is created when the file is filled up to the maximum size (specified in the settings, from 1 KB to 64 MB, see register 726), in case of an error writing to the file, removing the memory card or restarting the device. Before creating the file, the presence of files in the subfolder with names for the given day of the month is checked, and the maximum occupied index is found. Files are numbered starting from 01. The first 99 indices are numeric. After 99 indices follow A0...A9, AA...AZ, B0...ZZ. In total, up to 1035 indexes can be used for one day of the month, after which the recording can be suspended until the date changes (the beginning of the next day)
- EEE - file extension "CSV" or "DAT" (depending on settings, see register 725)

In the event of write errors, data remains in the write queue in temporary memory, and write attempts continue until the data is written or remains in the queue for more than 10 minutes. After that, the data is removed from the write queue, while the number of bytes that could not be written is added together, and this information about losses can be added to the log later.

3.1 Logging to Data Bytes Files

When the byte log format is selected, the EM-486 saves the collected data in a compact form to files with the "DAT" extension. Records of a fixed size of 16 bytes are appended to the files. Each record can contain the value of one parameter or a service message.

Service Record Format

Bytes	Field	Range of Values	Description
0 – 3	Time mark	0 – 4294967295	Number of seconds since midnight 1.01.1970 UTC+00
4 – 7	Service record code	4294967295	Indicator for distinguishing from other types of records
8 – 11	Message type	0	0 – losses due to repetitive errors
12 – 15	Message	0 – 4294967295	For loss reporting - the number of bytes

Parameter Record Format

Bytes	Field	Range of Values	Description
0 – 3	Time mark	0 – 4294967295	Number of seconds since midnight 1.01.1970 UTC+00
4	Parameter type	0 – 19, 128 – 147	Bits 0–6: Parameter type index (6 - parameter in the bit table (flags and digital inputs); other values - in the register table (storage and input), see Appendix C). Bit 7: 0 - parameter from the table for reading

Bytes	Field	Range of Values	Description
			and writing (flags, storage registers); 1 - parameter from the table is read-only (discrete inputs, input registers)
5	Device ID	1 – 247	Device address from which the data was received
6 – 7	Parameter address	0 – 65535	The address on the device where the data was read
8 – 11	Parameter value	-2147483648 – +2147483647	The value converted to a signed 32-bit integer
12 – 13	First register read	0 – 65535	Data read from the device before being converted to a parameter value
14 – 15	Second register read	0 – 65535	Used for parameter types that occupy two registers

3.2 Logging to Text Table Files

In a case of select the tabular format of the log, EM-486 saves the collected data in text form to files with the "CSV" extension. Records are added to the files in the form of text strings consisting of fields of variable length, separated by the character selected in the settings (see register 725). Lines are separated by a standard pair of characters (CR + LF for line feed). The maximum record length without adding a comment to the end of the line is 70 bytes. When using the logging command with a comment, the maximum line length depends on the format of the comment line and can be up to 200 bytes plus the length of the values substituted into the comment.

Text Table Record Format

Field	Description
1 Date	Date when the parameter value was received
2 Time	Time when the parameter value was obtained (in the time zone of the device)
3 Parameter value	The value converted to a signed 32-bit integer
4 Data type	Text entry of the type similar to that used in the task file (see Appendix C)
5 Parameter address	The address on the device where the data was read
6 Register table	One symbol representing a table on the device: H – storage registers; I – input registers; D – discrete inputs; C – flags
7 Identifier	Device address from which the data was received

Field	Description
8 Data losses	The number of bytes that could not be written and that were removed from the write queue before creating this record. 0 - no losses
9 Comment	An empty field or comment line if the entry was created by a logging command with a comment. It is not recommended to include the table field separator character in the comment

3.3 Filling the Memory Card

The time it takes for an empty memory card to be full can be calculated using the formula:

$$T_{full} \approx (V_{free} \times T_{new}) / (N_{par} \times L_{siz})$$

Where:

- T_{full} – The time it takes for an empty memory card to be full
- V_{free} – free space on the memory card
- T_{new} – update time of parameter values (see Appendix C)
- N_{par} – the number of parameters to be logged (if the record is made with each update)
- L_{siz} – the size of the log entry depending on its format

Examples:

1. When writing 7 parameters to the log in data byte format every 20 seconds - 2 GB card will be filled in 383479222 s (or more than 12 years)
2. When writing to the log in a tabular format (no comments) 3 parameters 10 times per second - the volume of 32 GB can be filled in 16361780 s (or more than 6 months)

When the logger mode is turned on (see register 727), after the free space on the memory card is exhausted, the oldest files can be deleted before writing new data. When the recorder mode is off, new data recording will be paused until space becomes available.

4. Export and Import Settings

EM-486 can export the saved settings from the internal memory to the "SETTINGS\EM486SET.DAT" file, or import the settings from this file and save them to the internal memory.

To export or import settings:

1. Enter the parameter settings (see section 5.3.3 of the manual)
2. Go to the "Files" tab
3. Select the transition to "Export settings"
4. To export to a file, click the "Export" button
5. To import the settings back from the file, click the "Import" button

The file can be up to 16 kB in size.

5. Saving Pulse Counters

EM-486 can save pulse counters at inputs in the "LOGS\COUNTERS" folder on the memory card. Files with names similar to the names of the log files in the data byte format are created in this folder (see Section 3). The size of each record is 24 bytes. The file size limit is 256 kB. When reading counters from a memory card after starting the device, the old files can be deleted if their number exceeds 3 files.

6. Firmware Updates

EM-486 can update the firmware (see Appendix G - Firmware Update) with one of three files:

- UPGRADES\EM486FW1.DAT
- UPGRADES\EM486FW2.DAT
- UPGRADES\EM486FW3.DAT

Files can be up to 10 MB each in size.

Appendix F: Web Interfaces

To access the device using a browser, the EM-486 expects an Ethernet connection to port 80 and HTTP transmissions. To connect in the address bar of the browser, call the IP address of the device (to display the address on the EM-486 display, see section 5.3.1 of the manual). The browser displays WEB pages that allow you to read the status of the device, set parameters, call MODBUS functions and perform file operations on the memory card.

In addition, the HTTP connection can be used by other applications to automatically invoke MODBUS functions using the API.

EM-486 supports API in two formats: JSON and XML. For example, if the IP address of the device is "192.168.0.111", then the API JSON request without parameters will look like `192.168.0.111/api.json`, and the XML API will look like `192.168.0.111/api.xml` (further in the examples, each request begins with one of these lines, and this beginning is referred to as `<API call>`).

API Response Without Parameters

An example of a response to a request is given below.

JSON format:

```
{
  "type": "EM-48x API",
  "version": "1.1",
  "device": "EM-486",
  "firmwareVersion": 43,
  "loginChallenge": "92uJzC89fQEdB62Jx0W75sGtNAmA"
}
```

XML format:

```
<ApiReply>
  <Type>EM-48x API</Type>
  <Version>1.1</Version>
  <Device>EM-486</Device>
  <FirmwareVersion>43</FirmwareVersion>
  <LoginChallenge>92uJzC89fQEdB62Jx0W75sGtNAmA</LoginChallenge>
</ApiReply>
```

Response Fields Description

JSON	XML	Description
(unnamed)	ApiReply	Root element of the response

JSON	XML	Description
type	Type	Response type (always "EM-48x API")
version	Version	Answer version
device	Device	Device
firmwareVersion	FirmwareVersion	Firmware version
loginChallenge	LoginChallenge	Secure authorization offer (see below)

Authorization

To access MODBUS authorization is required, which can be done in two ways:

1. The unprotected password by sending an API request with a password string in the `plainpass` parameter;
2. With SHA-1 protection using the authorization proposal received in the `loginChallenge` field. To do this, compute the standard SHA-1 hash of the string composed of the authorization clause and password, and then send an API request with the hash string (encoded in hexadecimal or BASE-64) in the `lcanswer` parameter. For example, for the factory password EM-486 "11111" and the sentence in the example above, the hash of the compound string "92uJzC89fQEdB62JxOW75sGtNAmA11111" in hexadecimal form is "28457e7fc55a67bf59caf5f73e42fd168a5fe6a3".

Upon successful authorization, the device returns a response with a redirection to the session page, for example, `/1c193447/api.xml` (hereinafter in the examples `<API session call>`), where "1c193447" is the temporary session code. If the application making the request does not support redirection, then the requests should be called with the `redirects` parameter set to "0".

Authorization Response Example

The response to the request `<API call>?lcanswer=28457e7fc55a67bf59caf5f73e42fd168a5fe6a3&redirects=0` if it was sent after the response above:

JSON format:

```
{
  "session": "1c193447",
  "status": "Ready"
}
```

XML format:

```
<ApiReply>
  <Session>1c193447</Session>
  <Status>Ready</Status>
</ApiReply>
```

Authorization Response Fields

JSON	XML	Description
session	Session	Session code. The absence of this element means that authorization is required. Authorized requests begin with <API session call> with the specified code.
status	Status	MODBUS call status: "Busy" - busy, a MODBUS call is being processed. The call should be repeated without parameters to get the result or to send a new call; "Ready" - ready, a new MODBUS call can be sent.

MODBUS Call

To call MODBUS, the following parameters are used:

Parameter	Range of Values	Description
mbc_uid	0–255	Destination device ID
mbc_func	1–6, 15–16	MODBUS function code. Only one value can be written for write functions, including multiple write functions (codes 15 and 16)
mbc_addr	0–65535	Register, flag or digital input address
mbc_data	0–65535	For read functions - the number of read values (from 1 to 16). For write functions, the value to be written
dosend	0–65535	The presence of this parameter with any value in the request makes a MODBUS call with the specified parameters

MODBUS Call Response Example

The answer to <API session call>?mbc_uid=111&mbc_func=3&mbc_addr=213&mbc_data=3&dosend=1 (for the value of the EM-486 own identifier equal to the factory default "111") - reading the current time:

JSON format:

```
{
  "type": "EM-48x API",
  "status": "Ready",
  "MODBUSQueries": [
    {
      "deviceID": 111,
      "function": 3,
      "address": 213,
      "data": 3,
      "response": {
        "data": [12, 38, 25]
      }
    }
  ]
}
```

XML format:

```
<ApiReply>
  <Type>EM-48x API</Type>
  <Status>Ready</Status>
  <MODBUSQuery>
    <UnitID>111</UnitID>
    <Function>3</Function>
    <Address>213</Address>
    <Data>3</Data>
    <Response>
      <Data>12</Data>
      <Data>38</Data>
      <Data>25</Data>
    </Response>
  </MODBUSQuery>
</ApiReply>
```

Successful MODBUS Call Response Fields

JSON	XML	Description
MODBUSQueries	MODBUSQuery	MODBUS request
unitID	UnitID	Destination device identifier in the request
function	Function	MODBUS function code in request
address	Address	Address of register, flag or discrete input in request

JSON	XML	Description
response	Response	Reply to request
data	Data	In a request - the number of read values or a written value, in a response - read or written data

MODBUS Error Response Fields

JSON	XML	Description
errorInQuery	ErrorInQuery	MODBUS request error (field in request instead of response field): "Query device ID illegal" - invalid device ID; "Query address illegal" - invalid address; "Query data illegal" - an invalid value
errorInResponse	ErrorInResponse	MODBUS response error (field in request instead of response field): "Response mismatch" - The accepted response does not match the request
exceptionCode	ExceptionCode	MODBUS exception code (field in response instead of data field)
exception	Exception	Exception MODBUS (field in response instead of data field, values are listed in table 5.2 of the manual)

Appendix G: Updating Firmware

General Information

To upgrade the integrated software, EM-486 uses files EM486FW1.FUS, EM486FW2.FUS or EM486FW3.FUS from folder UPGRADES located on SD memory card, formatted in the FAT or FAT32 format. Updating these files may be held in a special update mode of firmware.

Transmitting the EM-486 Updating Files

To transfer the update files, it is possible in two ways:

1. Record files to SD card on a personal computer or other external device and put the card into the EM-486, then enter the upgrade mode of the firmware, as shown in the table below;
2. If updating via the WEB interface is allowed in the parameter's settings, on the "Other" tab (see section 5.3.3 of the manual) - go to the "Files" tab, select the transition to "Firmware update", select the file and click the "Upload file". The file will be written to the "UPGRADES" folder named "EM486FW2.FUS". Then press the "Program" button. Wait for the update (3-4 minutes).

Firmware Updating Mode

The device can be set in mode of firmware updating after power supply and restart. The setting in that mode is made automatically (at updating via WEB-interface or at update failure) or manually (at the button "R" being pressed during a startup).

Entering the Mode of Software Updating

Nº	Step	Button "R"	Display	Time	Remark
1	Initialization	Pressed		0.5 s	To cancel the updating, release the button "R" at these steps
2	Stand-by	Pressed		1 s	
3	Notification about entering in mode of updating	Pressed	Entering upgrade mode	5 s	
4	Offer to enter the mode of updating	Pressed	To enter upgrade mode release button	2 s	To enter the mode of software updating, release the button "R" at this step
5	Protection against incidental pressing	Pressed	-	-	Holding the button pressed will cancel the firmware updating

Selection of Updating File

After manual entering in mode of updating, select the file of updating. To cancel the updating, cut off the power supply of EM-486 or wait until automatic completion of updating mode.

Nº	Step	Button "R"	Display	Time	Remark
1	Finding the available files		Searching for upgrade files...	(depends on the found files)	
3	Notification about entering in mode of updating	released	Name and version of updating file	5 s	To select a file, press and release the button "R" at this step
4	Offering all files of updating	released	–	(depends on the found files)	Repeat the step 3 for each file
6	Repeated offer	released	–	(depends on time of step 4)	Repeat the steps 3–4 for 3 times
7	Protection against incidental entering in the mode of updating	released	–	–	The file cancelation cause the escape from the mode of firmware updating

Updating of Integrated Firmware

At automatic entering into the mode of firmware updating or at manual selection of file, the updating is made from the file.

Nº	Step	Button "R"	Display	Time	Remark
1	Start of updating	–	Upgrading Firmware	2–10 s	
2	Updating the integrated software	–	(performance line shows the process of updating)	(depends on the file of updating)	Time until the end of process of updating is shown on the display
3	Updating is successfully completed	–	Firmware upgrade success	5 s	
4	Startup of firmware	–	–	–	

Error Codes

The errors detected during the updating process are shown on the display.

 **Caution**

If there are critical errors during the updating mode the operation of the device is not possible. In this case the indication of a critical error is made during an hour, after that the device automatically restarts. If an error is as a result of incidental event, the integrated firmware will be restored from the file on the memory card.

Codes of Warning in Software Updating Mode

Code	Warning	Actions	Remarks
2	Integrated firmware cannot be started	Initialization of mode of emergency updating: Auto start of updating from the selected file or from the first available file (if any)	The warning is shown at selection of firmware updating in WEB-interface or as a result of other error and is automatically corrected with the help of available files of software updating
3	Error while current process of firmware updating	Similar to N°2, but the file with an error has less priority	The error is automatically corrected with available files of updating
4	The files of updating are not available	Escape from the mode of updating, start of available integrated firmware	The device can continue operation but for reprogramming the file of updating should be loaded in the folder "UPGRADES" on the device SD memory card
5	Emergency mode – firmware cannot be started	Waiting for manual restart of device or restart automatically in 1 hour	The error is a result of three-time entering in emergency mode as a result of other errors. The correct file of firmware updating should be loaded in the folder "UPGRADES" on the SD memory card. If the error is repeated, contact the manufacturer
6	Emergency mode – error during the current firmware updating	Waiting for manual restart of device or restart automatically in 1 hour	The error is a result of three-time entering in emergency mode as a result of other errors. The correct file of firmware updating should be loaded in the folder "UPGRADES" on the SD memory card. If the error is repeated, contact the manufacturer
7	Unrecoverable error – no available files of updating, the integrated firmware cannot be started	Waiting for manual restart of device or restart automatically in 1 hour	The error is a result of three-time entering in emergency mode as a result of other errors. The correct file of firmware updating should be loaded in the folder "UPGRADES" on the SD memory card. If the error is repeated, contact the manufacturer

Task File Examples

Below there are examples of finished programs, each consists of a single task file. To run the sample on the EM-486 it is necessary:

1. Create a text file (with the extension ".txt") and program text
2. Place the file in the folder "TASKS"
3. Put the prepared folder on the memory microSD card, formatted in FAT or FAT32
4. Put the memory card in the EM-486

Available Examples

- Relay Control Based on OM-310 Fault - Turn on relay when OM-310 reports a fault
- Hysteresis Control for TR-101 - Control TR-101 hysteresis based on EM-486 temperature sensor
- Temperature Alarm with SMS - Send SMS and log temperature when threshold exceeded
- Simple Timer-Based Relay Control - Switch relay on/off at specified times of day
- Simple Temperature Control - Control relay based on temperature thresholds
- Astronomical Timer / Light Sensor - Street lighting control based on sunrise/sunset or light sensor

Relay Control Based on OM-310 Fault

This example describes a program that in the event of fault of the OM-310 will turn on the 1st relay on EM-486. In the text 3 – MODBUS ID of the device is OM-310; 240 is the register address which is monitored for the accident.

```
# enabling relay 1 depending on bit 0 of register 240 of device 3
!META
#9th version of Protocol
* PROTOCOLVERSION 9
# program run will be fulfilled every 3 seconds
* UPDATE 3
# in case of error of the parameter reading, it will be read again 2 times
* PARAMRETRIES 2
# limit of response waiting for MODBUS query is 1000 msec = 1 sec
* PARAMTIMEOUT 1000
# after each query the delay is added, equal to the response waiting time,
# so the other clients can perform their queries
* PARAMLOADRATIO 50

!DEVICES
# EM-486 can read and record no less than 120 registers per one query
# note the second character * - it is MODBUS ID of the EM-486 device
* * WRHANY 120 120
# OM-310 has MODBUS ID equal to 3 and allows reading 4 registers per one query,
# but to record only one register per one query
* 3 WRHSINGLE 4

!PARAMS
# during each updating, it is required to read the storage register with address 240,
# from the device with MODBUS ID equal to 3
# UINT16 - means that the 16-bit value and unsigned one (it can't be less than 0)
0 3 UINT16 H 240

!VARS
# copy zero bit of the register 240
# now in the variable the parameter value is 240.0
0 PARAMBIT P0 0

!CONDS
# variable V0 is compared with 1, condition is met, if V0 = 1
0 VAREQVAL V0 1
# condition is met, if the previous condition is not fulfilled and vice versa
1 NOT C0

!ACTS
# enable the first relay, the second parameter is the number of the relay
0 RELAYON 1 1
# disable the first relay
1 RELAYOFF 1 1
```

```
!REACTS
# if C0 condition is fulfilled (if 240.0 = 1), then hold the relay 1 enabled
* C0 REPEAT A0
# if C1 condition is fulfilled (if 240.0 is not equal to 1), then the relay 1 is
disabled
* C1 REPEAT A1
# END - a comment at the end of the file, or an empty line, for correct reading
```

Hysteresis Control for TR-101

In this example, the program controls the hysteresis value on the second channel of the TR-101 device, depending on the temperature on the sensor of the first input of EM-486. In the text 16 – MODBUS ID of the device is TR-101; 47 is the address of register for the hysteresis of the second channel TR-101.

The program uses registers in the field of current user settings 5500-5749. Registers 5500 and 5501 are reserved for the values respectively of the lower and upper temperature limits and the registers 5502 and 5503 are for the hysteresis value to be set in TR-101 if achieving the temperature respectively the lower or upper limits. These registers are read-only. To change them, you should be in configuration mode (see para. 5.3.4), then write the desired values to addresses of the respective editable settings. These addresses are obtained by subtracting 250 from the address current value. Thus, temperature limits are recorded into the registers 5250 and 5251, and the hysteresis – 5252 and 5253. Then, in order for the changes to take effect, you need to give the commands "Save" and "Apply" (for example by writing 4 to the register 120).

```
!META
* PROTOCOLVERSION 9
# program will run every 20 seconds
* UPDATE 20
* PARAMACTUAL 0
* PARAMLOADRATIO 50

!DEVICES
* * WRHANY 120 120
# TR-101 has MODBUS ID as 16 and can read no less than 100 registers per a query,
# but to record by one register per one query
* 16 WRHSINGLE 100

!PARAMS
# INT16 – registers with sign, as the temperature can be less than 0
0 * INT16 H 5500
1 * INT16 H 5501
2 * INT16 H 150
# UINT16 – as the hysteresis is no less than 0
3 * UINT16 H 5502
4 * UINT16 H 5503
5 16 UINT16 H 47

!VARS
# lower temperature limit
0 PARAMVAL P0
# upper temperature limit
1 PARAMVAL P1
# temperature value
2 PARAMVAL P2
# hysteresis for temperature below lower limit
3 PARAMVAL P3
# hysteresis for temperature above the upper limit
4 PARAMVAL P4
# hysteresis value
5 PARAMVAL P5

!CONDS
# is the temperature higher than the upper limit?
0 VARGEVAR V2 V0
# is hysteresis set for the desired value for the upper limit?
1 VAREQVAR V2 V1
# in other cases – do not change the hysteresis (current value)
2 CONDIS 1
```

```
!VARS
# the desired hysteresis is selected from V3 - V5, according to the conditions of C0
- C2
6 VARSSELBYC V3 C0

!CONDS
# is hysteresis set for the desired value?
3 VARNEVAR V5 V6

!ACTS
# record to TR-101 the new hysteresis
0 PARAMWRVAR P5 V6

!REACTS
* C3 REPEAT A0
# program is completed
```

Temperature Alarm with SMS

In this example, a program is described that reads the temperature measured by OB-215, and when the temperature exceeds -15 degrees for more than 10 minutes, sends an SMS and starts logging the temperature values. In text 11 - MODBUS ID of the OB-215 device; 6 - address of the register from which the temperature is read.

```
!META
* PROTOCOLVERSION 9
# the program will run every 15 seconds
* UPDATE 15

!DEVICES
* * WRHANY 120 120
* 11 WRHSINGLE 4

!PARAMS
0 11 UINT16 H 6
# alarm flag – temperature rise for more than 10 minutes
1 * UINT16 H 5000
# counter for a delay of 10 minutes
2 * UINT16 H 5001

!VARS
0 PARAMVAL P0
1 PARAMVAL P1
2 PARAMVAL P2
# next counter value (15 seconds elapsed)
3 VARADDVAL P2 15
# temperature limit
4 VAL -15
# delay counter limit (10 * 60 = 600 seconds)
5 VAL 600

!CONDS
# temperature above the limit at -15?
0 VARGRVAR V0 V4
# temperature below the limit?
1 NOT C0
# the counter has reached the limit of 10 minutes?
2 VARGEVAR V1 V5
3 NOT C2
# increase the counter if it is not overfilled and the temperature is outside the
limit?
4 AND C0 C3
# crash flag set?
5 VARNEVAL V2 0

!STRS
# SMS text into which the current and limit temperatures will be inserted
0 0B-215 (11) – avaria, tmp *V0* > *V4*
```

```
!PHONES
# below can be specified phone number for receiving SMS
0 01234567

!ACTS
0 PARAMWRVAL P1 0
1 PARAMWRVAL P2 0
2 PARAMWRVAL P1 1
3 PARAMWRVAR P2 V3
4 SENDSMS H0 S0
5 PARAMCOMMENT P0 S0

!REACTS
* C1 REPEAT A0
* C1 REPEAT A1
* C2 REPEAT A2
* C4 REPEAT A3
* C5 ACT A4
* C5 REPEAT A5
#END
```

Simple Timer-Based Relay Control

This program example switches the EM-486's relay on/off depending on time of day. At the specified times of the day it switches the relay OFF and ON. Required condition is that OFF-time should be before (less than) ON-time.

The program is controlled through Overvis using registers on EM-486 device.

Address	Description
5250	OFF time of day in seconds (e.g. 12:34 is $12 \times 3600 + 34 \times 60 = 45240$).
5251	ON time of day in seconds.



```
!META
* PROTOCOLVERSION 9

!PARAMS
# Current time of day in seconds (EM-486 register)
0 * INT32 H 230
# Setting: Time to turn relay OFF, in seconds
1 * INT32 H 5500
# Setting: Time to turn relay ON, in seconds
2 * INT32 H 5502
# EM-486 relay 1 state
3 * UINT16 H 160

!VARS
# Current time of day in seconds
0 PARAMVAL P0
# Time to turn relay OFF, in seconds
1 PARAMVAL P1
# Time to turn relay ON, in seconds
2 PARAMVAL P2
# EM-486 relay 1 state
3 PARAMVAL P3

!CONDS
# Time of day has already reached switching off time today
0 VARGEVAR V0 V1
# Time of day hasn't yet reached switching on time today
1 VARLSVAR V0 V2
# Relay 2 is switched on
2 VAREQVAL V3 1
# Relay 2 is switched off
3 VAREQVAL V3 0
# It's time to switch the relay OFF
4 AND C0 C1
# It's time to switch the relay ON
5 NOT C4
# Relay should be switched ON
6 AND C3 C5
# Relay should be switched OFF
7 AND C2 C4

!ACTS
0 RELAYON 1 1
1 RELAYOFF 1 1
```

```
!REACTS
```

```
* C6 ACT A0
```

```
* C7 ACT A1
```

```
# END.
```

This program can be modified to control the OB-215 relay with EM-486. In that case, parameter P3 should be changed to the relay register of OB-215 and ON/OFF actions (section !ACTS) should be changed to the OB-215 control register command. See Astronomical Timer example for reference.

Simple Temperature Control

This example program switches the EM-486 relay on/off depending on sensor reading. If sensor reading is below minimum value, then relay is turned ON. If sensor reading is above maximum value, then relay is turned OFF. In between - relay state is undefined (not controlled by EM-486).

The program is controlled through Overvis using registers on EM-486 device.

Address	Description
5250	Lower temperature threshold
5251	Upper temperature threshold



```
!META
* PROTOCOLVERSION 9

!PARAMS
# EM-486 input 1 (connect temperature sensor to input 1)
0 * INT16 H 150
# Setting: Lower temperature threshold – Overvis parameter address 5250
1 * INT16 H 5500
# Setting: Upper temperature threshold – Overvis parameter address 5251
2 * INT16 H 5501
# EM-486 relay 1 state
3 * UINT16 H 160

!VARS
# Temperature sensor value
0 PARAMVAL P0
# Lower temperature threshold setting
1 PARAMVAL P1
# Upper temperature threshold setting
2 PARAMVAL P2
# Relay 1 state
3 PARAMVAL P3

!CONDS
# Temperature value is below lower border
0 VARLSVAR V0 V1
# Temperature value is higher than upper border
1 VARGRVAR V0 V2
# Relay 1 is switched on
2 VAREQVAL V3 1
# Relay 1 is switched off
3 VAREQVAL V3 0
# Relay should be switched on
4 AND C0 C3
# Relay should be switched off
5 AND C1 C2

!ACTS
0 RELAYON 1 1
1 RELAYOFF 1 1

!REACTS
* C4 ACT A0
* C5 ACT A1
```

```
# END.
```

This program can easily be modified to control the OB-215 relay with EM-486. In that case, parameter P3 should be changed to relay value of OB-215 and ON/OFF actions (section !ACTS) should be changed to OB-215 control register modifications. See Astronomical Timer example for reference.

Astronomical Timer / Light Sensor

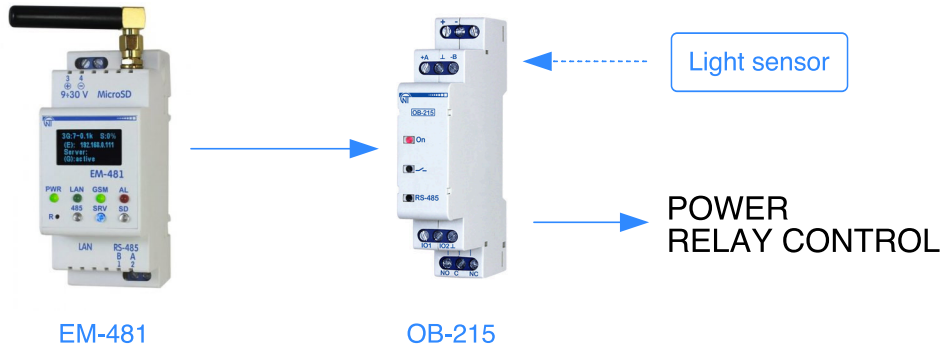

This example EM-486 program turns on/off the OB-215 relay based on sunset/sunrise or light sensor connected to OB-215.

It also includes additional energy saving interval (during night) when the relay should be switched off.



Usage

The program is controlled through Overvis using registers on EM-486 device.

Logic mode setting:

Address	Description
5256	Logic mode switch (1 = astronomical timer, 2 = sensor-based).

Astronomical timer mode settings:

Address	Description
5250	Shift in seconds before sunrise (to switch relay OFF).
5251	Shift in seconds after sunset (to switch relay ON).
5252	Time of day in seconds to force-switch relay OFF to enter energy saving period.
5254	Time of day in seconds to force-switch relay ON to exit energy saving period.

Sensor-based mode settings:

Address	Description
5257	Sensor threshold: below this threshold relay will be switched OFF, above or equal to threshold - ON.

Code



```
!META
* PROTOCOLVERSION 9
# By default – updating once per minute

# This program assumes that OB-215 is connected on MODBUS ID 2 (see params 9 and 10,
and section !ACTS).

# In this section we assign numbers to device's parameters (registers).
# The assigned number is the first column.
# "*" in second column means that we assign controller's addresses (EM-486's).
!PARAMS
# Time of day, s (integrated EM-486 register)
0 * INT32 H 230
# Time of sunrise, s (integrated EM-486 register)
1 * INT32 H 232
# Sunset time, s (integrated EM-486 register)
2 * INT32 H 234
# Shift for sunrise in seconds. Shift is subtracted from sunrise time.
# In Overvis, this parameter can be changed through address 5250.
3 * INT16 H 5500
# Shift for sunset in seconds. Shift is added to sunset time.
# In Overvis, this parameter can be changed through address 5251.
4 * INT16 H 5501

# Additional energy saving mode: time in seconds after midnight to turn relay off.
# E.g. to turn off at 01:00, set this to 3600.
#     to turn off at 23:00, set this to 3600*23 = 82800.
# In Overvis, this parameter can be changed through address 5252.
5 * INT32 H 5502
# Additional energy saving mode: time in seconds after midnight to turn relay on.
# E.g. to turn on at 05:00, set this to 3600*5 = 18000.
# In Overvis, this parameter can be changed through address 5254.
6 * INT32 H 5504

# Logic mode: 1 – astronomical timer, 2 – based on light level sensor.
# In Overvis, this parameter can be changed through address 5256.
7 * INT16 H 5506
# Light level to turn relay off. Used if logic mode = 2 (param 7).
# In Overvis, this parameter can be changed through address 5257.
8 * INT16 H 5507

# OB-215 – current light level (from sensor).
# Assuming OB-215 has MODBUS ID 2 and has light sensor connected.
```

```
# Used only if logic mode = 2 (param 7)
9 2 INT16 H 6

# 0B-215 - relay control register
10 2 INT16 H 50

!VARS
# V0 - Time of day, s (integrated EM-486 register)
0 PARAMVAL P0
# V1 - Time of sunrise, s (integrated EM-486 register)
1 PARAMVAL P1
# V2 - Sunset time, s (integrated EM-486 register)
2 PARAMVAL P2
# V3 - Shift for sunrise in seconds
3 PARAMVAL P3
# V4 - Shift for sunset in seconds
4 PARAMVAL P4
# V5 - Shifted sunrise time: V1 - V3
5 VARSUBVAR V1 V3
# V6 - Shifted sunset time: V2 + V4
6 VARADDVAR V2 V4
# V7 - Additional energy saving mode: time in seconds after midnight to turn relay
off.
7 PARAMVAL P5
# V8 - Additional energy saving mode: time in seconds after midnight to turn relay
on.
8 PARAMVAL P6
# V9 - Logic mode: 1 - astronomical timer, 2 - based on light level sensor.
9 PARAMVAL P7
# V10 - Light level to turn relay off.
10 PARAMVAL P8
# V11 - Current light level (from sensor).
11 PARAMVAL P9
# V12 - Error value constant for the light sensor.
# If this value is received from sensor, we ignore the sensor value.
12 VAL 32767

!CONDS

# C0: V0 >= V5 (Current time is greater than shifted sunrise time)
0 VARGEVAR V0 V5
# C1: V0 <= V6 (Current time is less than shifted sunset time)
1 VARLEVAR V0 V6
```

```
# C2: C0 && C1 (We are currently in between sunrise and sunset, i.e. it's daytime)
2 AND C0 C1
# C3: !C2 (We are not currently in between sunrise and sunset, i.e. it's nighttime)
3 NOT C2

### Additional energy saving period:

# C4: V8 > V7
# Time to turn on the relay for additional saving is
# after the time to turn the relay off, e.g. OFF at 01:00 and ON at 06:00.
# Inverse of this condition is processed in C11.
4 VARGRVAR V8 V7
# C5: V0 >= V7
# Current time is greater than turn off time for additional energy saving.
5 VARGEVAR V0 V7
# C6: V0 <= V8
# Current time is less than turn on time for additional energy saving.
6 VARLEVAR V0 V8
# C7: C5 && C6 = (V0 >= V7) && (V0 <= V8)
# We are in additional energy saving period (we have to turn relay off during that
period).
7 AND C5 C6
# C8: C4 && C7 = (V8 > V7) && (V0 >= V7) && (V0 <= V8)
# We are in additional energy saving period, and this period is in the same day
# (i.e. starts after midnight and ends after midnight).
# The relay should be switched off in that case.
8 AND C4 C7
# C9: C2 || C8 = ((V0 >= V5) && (V0 <= V6)) || ((V8 > V7) && (V0 >= V7) && (V0 <=
V8))
# Either currently is daytime or we are in energy saving mode.
# In any case we have to turn relay off.
9 OR C2 C8
# C10: !C9 (Relay should be on)
10 NOT C9

# C11: !C4
# Time to turn on the relay for additional saving is
# before the time to turn the relay off, e.g. OFF at 22:00 and ON at 06:00.
# If this is the case, we have to invert additional energy saving logic.
11 NOT C4
# C12: C5 || C6 = (V0 >= V7) || (V0 <= V8)
# We are in inverted additional energy saving period (we have to turn relay off
during that period).
12 OR C5 C6
# C13: C11 & C12 = (V8 <= V7) && ((V0 >= V7) || (V0 <= V8))
```

```
# We are in additional energy saving period, and this period spans during two days
# (i.e. starts before midnight and ends after midnight).
# The relay should be switched off in that case.
13 AND C11 C12
# C14: C2 || C13 = ((V0 >= V5) && (V0 <= V6)) || ((V8 <= V7) && ((V0 >= V7) || (V0 <=
V8)))
# Either currently is daytime or we are in energy saving mode.
# In any case we have to turn relay off.
14 OR C2 C13
# C15: !C10 (Relay should be on)
15 NOT C14

### Logic mode (astronomical or sensor)

# C16: V9 == 1 (we are in astronomical timer mode)
16 VAREQVAL V9 1
# C17: V9 == 2 (we are in light sensor mode)
17 VAREQVAL V9 2

### Astronomical timer mode:

# C18: C16 && C9
# We are in astronomical timer mode and relay should be off.
18 AND C16 C9
# C19: C16 && C10
# We are in astronomical timer mode and relay should be on.
19 AND C16 C10
# C20: C16 && C14
# We are in astronomical timer mode and relay should be off.
20 AND C16 C14
# C21: C16 && C15
# We are in astronomical timer mode and relay should be on.
21 AND C16 C15

### Light sensor mode:

# C22: V11 < V10 (Current light level is less than threshold).
22 VARLSVAR V11 V10
# C23: C17 && C22 = V9 == 2 && V11 < V10
# We are in light sensor mode and current light level is less than threshold.
23 AND C17 C22
# C24: V11 >= V10 (Current light level is greater than than threshold).
24 NOT C22
# C25: C17 && C24 = V9 == 2 && V11 >= V10
# We are in light sensor mode and current light level is greater than threshold.
```

```
25 AND C17 C24
# C26: V11 == V12 (Current sensor reading is ERROR).
26 VAREQVAR V11 V12
# C27: C17 && C26 (We are in light sensor mode and current sensor reading is ERROR).
27 AND C17 C26
# C28: C23 || C27
# We are in light sensor mode and
#   current light level is less than threshold or reading is ERROR.
28 OR C23 C27
# C29: V11 != V12 (Current sensor reading is not ERROR).
29 NOT C26
# C30: C25 && C29
# We are in light sensor mode and current light level is greater than threshold
#   and current sensor reading is not ERROR.
30 AND C25 C29

### Incorrect mode:

# C31: !C16 (we are not in astronomical timer mode)
31 NOT C16
# C32: !C17 (we are not in light sensor mode)
32 NOT C17
# C33: !C16 && !C17 (we are in incorrect mode: parameter P7 has not 1 or 2 value).
33 AND C31 C32

!ACTS
# Turn relay ON
0 PARAMWRVAL P10 14262
# Turn relay OFF
1 PARAMWRVAL P10 14263

!REACTS
# Turn relay OFF if we are in astronomical timer mode and relay should be off.
* C18 ACT A1
# Turn relay ON if we are in astronomical timer mode and relay should be on.
* C19 ACT A0
# Turn relay OFF if we are in astronomical timer mode and relay should be off.
* C20 ACT A1
# Turn relay ON if we are in astronomical timer mode and relay should be on.
* C21 ACT A0

# Turn relay ON if we are in light sensor mode and
#   current light level is less than threshold or reading is ERROR.
```

```
* C28 ACT A0
# Turn relay OFF if we are in light sensor mode and
#   current light level is greater than threshold and reading is not ERROR.
* C30 ACT A1

# Turn relay OFF if we are in incorrect mode.
* C33 ACT A1

# END.
```

This program can be easily modified to work on EM-486 without OB-215. In that case, actions (section !ACTS) and P10 should be changed to control EM-486 relay and param P9 should be changed to read EM-486's sensor input.