



Novatek-Electro EM-125 Documentation

<https://www.overvis.com/docs/uk/em-125/>

2026-03-30

Table of Contents

1. Novatek-Electro EM-125
2. EM-125 Operating Manual

Novatek-Electro EM-125



EM-125 — це багатофункціональне реле часу з підтримкою Wi-Fi (розумна розетка) виробництва NOVATEK-ELECTRO LTD. Призначений для домашньої автоматизації, дозволяючи користувачам керувати навантаженнями за розкладом або вручну, одночасно захищаючи їх від аномалій напруги та перевантажень.

 **Доступна повна документація**

Переглянути всю документацію на одній сторінці – Ідеально для друку або читання офлайн

Ключові особливості

- Вимірювання напруги та частоти
- Вимірювання струму та потужності навантаження
- Облік споживання електроенергії
- Захист навантаження від аномальної напруги
- Захист навантаження від надструму
- Захист навантаження від перевантаження по потужності
- Годинник реального часу з резервуванням до 5 днів
- Автоматична синхронізація часу з сервером SNTP
- Автоматичне керування навантаженням за розкладом користувача (до 512 подій)
- Планування відпустки (з блокуванням виконання програми)
- Обмеження часу роботи навантаження
- Ручне керування навантаженням з передньої панелі
- Батьківський контроль (блокування ручного керування через заданий час)
- Дистанційне керування та налаштування через хмарний сервер my.overvis.com

Типові застосування

- Автоматизація розумного дому
- Керування опалювальним та вентиляційним обладнанням за розкладом
- Моніторинг споживання електроенергії та відстеження витрат
- Захист навантаження для чутливого обладнання
- Дистанційне керування пристроями через інтернет

Документація

- **Інструкція з експлуатації** – Повні інструкції з експлуатації, налаштування та параметрів захисту

Додаткові ресурси

- Документація на одній сторінці – Повна документація на одній сторінці для друку
- Повна інструкція EM-125 (PDF) – Повна інструкція з експлуатації

Підтримка

- **Центр підтримки:** Відвідайте наш Центр підтримки
- **Повідомити про проблему:** Надішліть заявку

EM-125 Operating Manual



WI-FI CONTROL

MULTIFUNCTIONAL TIMER RELAY

EM-125

OPERATING MANUAL

PASSPORT

Quality management system for product development and manufacturing complies with ISO 9001:2015 requirements

Dear Customer,

NOVATEK-ELECTRO thanks you for purchasing our product.

After carefully studying this Operating Manual, you will be able to use the product correctly. Keep this Operating Manual throughout the entire service life of the product.

Ukraine, Odesa — www.novatek-electro.com

1 Purpose

The multifunctional timer relay EM-125 (hereinafter referred to as the product or EM-125) is a microprocessor device designed for home automation — a smart plug.

EM-125 allows you to turn on/off loads according to a schedule or manually, while simultaneously protecting the load from various voltage emergencies and power overloads.

After registration on the "my.overvis.com" server, control and configuration of EM-125 is possible from anywhere in the world with an internet connection.

EM-125 accumulates energy consumption statistics in real time and sends the accumulated data to the "my.overvis.com" server, allowing you to view saved reports for a week, month, or year.

You can save electricity and reduce your costs by using EM-125 to control heating and ventilation equipment according to a pre-planned schedule.

Main Features

- Voltage and frequency measurement of the mains
- Measurement of current consumed by the load
- Measurement of power consumed by the load
- Accounting of electricity consumed by the load
- Protection of load from emergency mains voltage
- Protection of load from exceeding consumption current
- Protection of load from exceeding consumption power
- Real-time clock with up to 5-day backup (without power supply)
- Automatic time synchronization with SNTP server
- Automatic load control according to a user-defined schedule
- Vacation planning (with blocking of program execution)
- Load operation time limiting
- Manual load control from the front panel
- Blocking of manual control after a specified time interval (child protection)

Controls

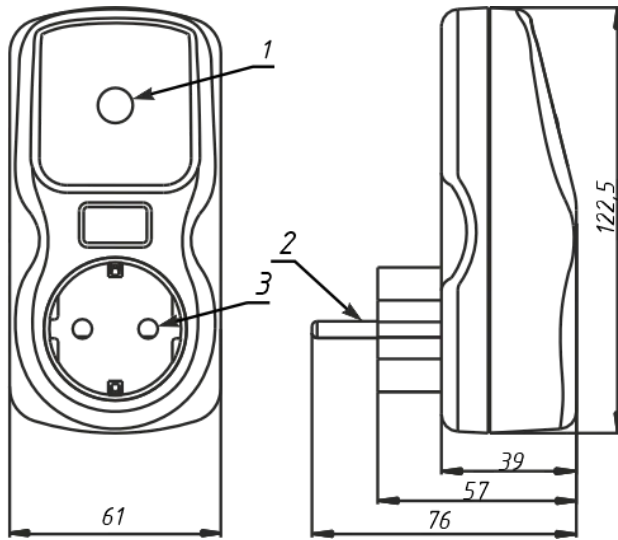

1 — "ENTER" control and indication button

2 — "Plug" — for connecting to the mains

3 — "Socket" — for connecting the load

Figure 1 — EM-125 Controls

"ENTER" Button Indication

- Blue (flashing with 0.5 s period) — connecting to Wi-Fi access point
- Blue (on) — load is on
- Blue (off, flashes every 5 seconds) — power is on, load is off
- Red (flashing with 0.5 s period) — automatic reclosing (AR) countdown in progress
- Red (on) — emergency present or device is locked due to emergency
- Blue-red (flashing with 0.35 s period) — Wi-Fi connection setup mode enabled
- Blue-red (flashing with 0.1 s period) — factory reset in progress
- Purple (flashing with 0.1 s period) — firmware update in progress

2 Terms and Abbreviations

Wi-Fi — a set of standards for transmitting digital data streams via radio channel

RMS — Root Mean Square (effective) value

AR — Automatic Reclosing of the load

Default — preset parameter values that the product uses in its operation until the user explicitly changes these values

Web interface — a system for user interaction with the product through a computer browser

Purple — indicator color obtained by mixing blue and red light

3 Technical Specifications

Parameter	Value
Rated supply voltage	220 – 240 V
Mains frequency	45 – 62 Hz
Operating voltage range	100 – 400 V
Maximum switching current with resistive load	16 A
Connected load power	≤ 3.6 kW
Readiness time upon power supply	≤ 0.4 s
Mains voltage measurement accuracy	±3 V
Load current measurement accuracy	±0.3 A
Real-time clock accuracy ¹	±1 s/day
Real-time clock backup ²	up to 5 days
Wi-Fi frequency	2.412 – 2.484 GHz
Supported Wi-Fi standards	IEEE 802.11 b/g/n
Wi-Fi encryption protocol	WPA2/PSK
SNTP time synchronization protocol	yes
Data exchange protocol with "my.overvis.com" server	yes
Maximum number of events (schedule)	512
Maximum log length	10,000 records
Log record type	circular
Log record period	5 minutes
Product purpose	Control and distribution equipment
Nominal operating mode	Continuous
Climatic version	UHL 4
Device protection rating	IP30
Switching resource of output contacts at $\cos\phi=1$: under 16 A load	≥100,000 times
Switching resource of output contacts at $\cos\phi=1$: under 5 A load	≥1,000,000 times
Power consumption (under load)	≤ 2.5 W

Parameter	Value
Permissible pollution degree	II
Overvoltage category	II
Protection class against electric shock	I
Rated insulation voltage	450 V
Rated impulse withstand voltage	2.5 kV
Weight	≤ 0.16 kg
Overall dimensions, H×W×L	see Figure 1

The product maintains its functionality in any spatial orientation.

Case material — self-extinguishing plastic.

The product complies with: DSTU EN 60947-1:2017; DSTU EN 60947-6-2:2014; DSTU EN 55011:2017; DSTU EN 61000-4-2:2018.

No harmful substances in quantities exceeding maximum permissible concentrations.

¹ — provided that SNTP server synchronization is enabled

² — provided that the product has been powered from the mains for at least 30 minutes

4 Operating Modes

The product can operate in three modes:

- Normal operation mode
- Manual control mode
- Wi-Fi connection setup mode

Normal Operation Mode

EM-125 connects to the user-specified access point, performs measurements and monitors mains parameters (voltage and current) to protect the load according to the user-defined schedule.

In case of an emergency (current or voltage value exceeding the set level, voltage dropping below the set level), the product performs emergency load disconnection.

Manual Control Mode

If the user manually changed the load state from the front panel or remotely via the “my.overvis.com” server, EM-125 blocks the execution of the current scheduled event and switches to manual control mode.

After the next scheduled event occurs, EM-125 returns to normal operation mode.

The manual control state is remembered even after the product is disconnected from the mains.

Wi-Fi Connection Setup Mode

In Wi-Fi connection setup mode, EM-125 creates its own access point named "EM-125_xxxxxxx", where xxxxxxxx is the unique product code.

The user, by connecting to this access point and using a web browser (Opera, Google Chrome, Firefox, etc.) to navigate to "http://192.168.4.1", gains access to the product's Wi-Fi connection settings.

5 Product Connection

Caution

When EM-125 is connected to the mains, dangerous voltage is present on the socket contacts and internal components of the product.

Caution

The product is not designed for switching loads during short circuits. Therefore, the product must be operated in an electrical network protected by a circuit breaker with a trip current of no more than 16 A.

It is prohibited to connect loads with power exceeding 3.6 kW to the product.

The load current must not exceed the maximum current of the socket to which the product is connected.

To connect:

- Connect the load to the EM-125 socket
- Plug EM-125 with the load into the mains socket

6 Product Configuration

Wi-Fi Connection Setup

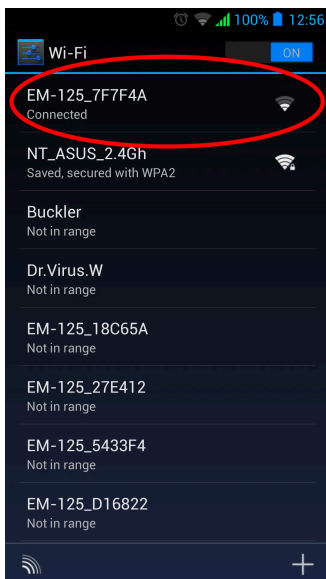

To enter the setup mode, press and hold the "ENTER" button (Fig. 1, pos. 1) on the front panel of the product for 5-6 seconds. The "ENTER" button will start flashing blue-red and EM-125 will create an access point named "EM-125_xxxxxxx", where xxxxxxxx is the unique product code (see Fig. 2).

Using an electronic device (PC with Wi-Fi, phone, tablet, laptop, etc.), connect to the access point using the following parameters:

- Access point name: "EM-125_xxxxxxx"
- Security: None

Launch a web browser (Google Chrome, Opera, Firefox, etc.) on the electronic device.

In the browser address bar, enter "http://em.com" or "http://192.168.4.1" and navigate to the entered link.

The EM-125 web interface will be displayed on the electronic device screen.

Follow the on-screen instructions to configure the Wi-Fi connection for EM-125 and complete authorization on the "my.overvis.com" server.

Note

To force exit from Wi-Fi connection setup mode — press and hold the "ENTER" button on the front panel for 5-6 seconds, the "ENTER" button will stop flashing blue-red, and the product will switch to normal operation mode.

Web Interface Description

User Authorization

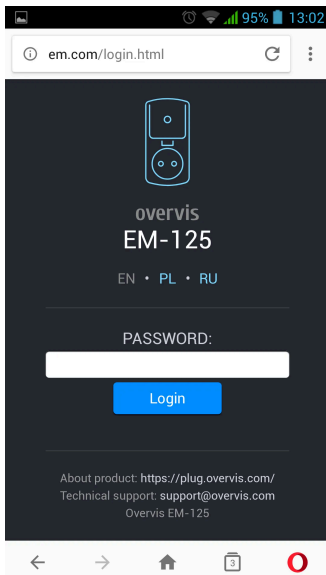

After opening the EM-125 web interface in a PC browser (or any other device with a browser installed), the user authorization page will be displayed.

To access EM-125, you need to enter the login (default "EM-125") and password (default "admin").

Status



After successful authorization, the status page will be displayed, showing current information about the EM-125 state. All information is read-only.

At the top of the screen, the device name “overvis EM-125”, current power consumption by the load “0 W”, and the “≡” button for opening the main menu are displayed.

In the middle of the screen, there is a manual control button and readings of measured mains parameters (load current and power, mains voltage and frequency).

At the bottom of the screen, there are counters of consumed electricity and the amount of money spent.

Main Menu

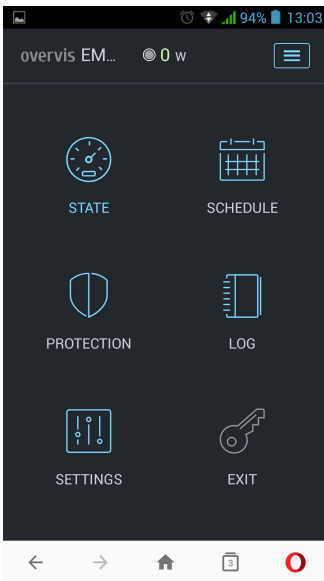

After pressing the "≡" button, the main menu of the product will be displayed.

To close the menu, press the "≡" button.

Schedule

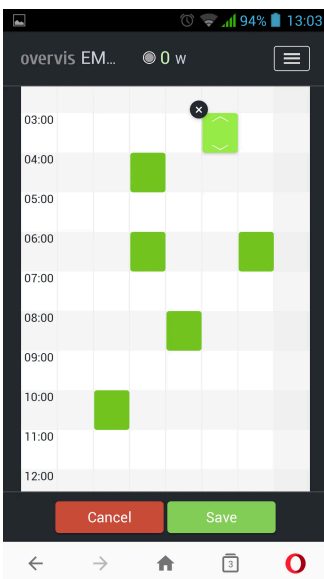

Opens after navigating to the "SCHEDULE" menu item.

Double-clicking on the graph adds an event.

Double-clicking on an event opens the event settings window.

Changing the event time is done by dragging the entire block or using the "◀" and "▶" elements.

To delete an event, press "X" in the upper left corner of the event.

To save the current schedule to EM-125 — press the "Save" button. To cancel changes — press the "Cancel" button.

Protection

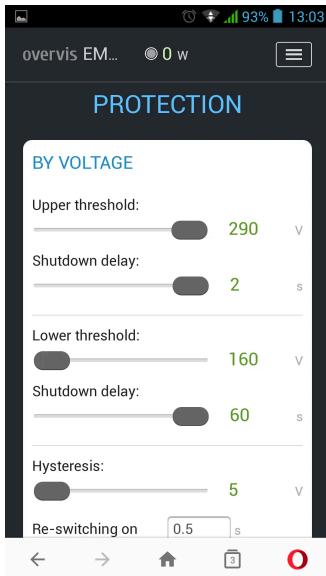

Opens after navigating to the “PROTECTION” menu item.

This menu item contains the protective function settings for EM-125:

- Voltage protection
- Current protection
- Power protection

Voltage Protection:

- Upper threshold — maximum voltage value at which the load will be disconnected
- Disconnect delay — protection response time when the threshold is reached
- Lower threshold — minimum voltage value at which the load will be disconnected
- Hysteresis — voltage hysteresis value
- Reconnection delay — delay before reconnecting the load after an emergency
- Reconnections — number of allowed reconnections after an emergency
- Save — save settings to EM-125

Current Protection:

- Current threshold — protection state at which the load will be disconnected
- Disconnect delay — protection response time when the threshold is reached
- Reconnection delay — delay before reconnecting the load after an emergency
- Reconnections — number of allowed reconnections after an emergency
- Save — save settings to EM-125

Power Protection:

- Protection — protection operation mode (disabled, by active or apparent power)
- Power threshold — power value at which the load will be disconnected

- Disconnect delay — protection response time when the threshold is reached
- Reconnection delay — delay before reconnecting the load after an emergency
- Reconnections — number of allowed reconnections after an emergency
- Save — save settings to EM-125

Settings

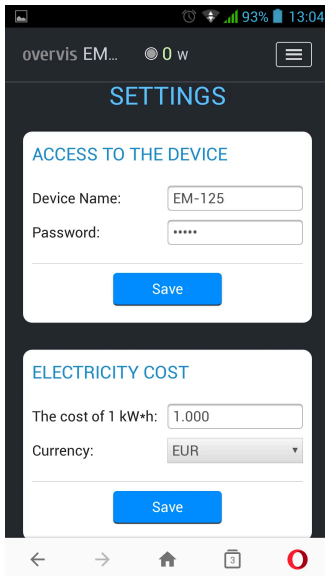

Opens after navigating to the "SETTINGS" menu item.

This menu item contains the main EM-125 settings:

- Device access
- Electricity cost
- Wi-Fi
- Vacation
- Date and time
- Overvis Cloud
- Advanced

Device Access:

- Device name — product name
- Password — sets the access password to EM-125 via Web interface
- Save — save settings to EM-125

Electricity Cost:

- Cost per 1 kWh — sets the electricity cost per 1 kWh
- Currency — sets the currency in which the cost of consumed electricity is calculated
- Save — save settings to EM-125

Wi-Fi:

- Network name (SSID) — name of the network to which EM-125 is connected
- Network password — password of the network to which EM-125 is connected
- TCP/IP settings — TCP/IP configuration mode (manual or automatic DHCP)
- IP address — EM-125 IP address in the Wi-Fi network
- Subnet mask — subnet mask of the network to which EM-125 is connected
- Default gateway — default gateway address in the Wi-Fi network
- Save — save settings to EM-125

Vacation:

- Enable scheduled vacation — vacation planner operation mode (disabled or enabled)
- Start date — vacation planner start date
- End date — vacation planner end date
- Save — save settings to EM-125

Note

During vacation planner operation, the load is blocked from turning on.

Date and Time:

- Device time — current date and time on the device
- Time zone — current time zone on the device
- Enable automatic daylight saving time switch — parameter that allows or prohibits EM-125 from automatically switching to/from daylight saving time
- Time correction — clock correction on EM-125, specified in seconds per day
- Enable time synchronization — parameter that allows or prohibits the product from synchronizing time with an NTP time server
- NTP server address — NTP time server address
- Port — NTP time server connection port
- Synchronization period — period at which EM-125 will synchronize with the NTP time server
- Save — save settings to EM-125
- Synchronize with server — force time synchronization between the NTP time server and EM-125
- Synchronize with PC — start time synchronization between PC and EM-125

Overvis Cloud:

- Enable remote access via cloud — allow or prohibit EM-125 connection to Overvis cloud
- Server address — sets the Overvis cloud address
- Port — connection port
- Status — service information about the Overvis cloud connection status
- Save — save settings to EM-125

Advanced:

- Front panel lock after — time after which the front panel will be locked after power is applied to EM-125 (child protection)
- Device lock after — time after which load activation will be blocked for all operating modes
- Reconnection counter reset time — time after which the allowed reconnection counters will be reset from the moment the emergency disappears
- Indication brightness — sets the brightness of the EM-125 control button backlight
- Save — save settings to EM-125

Configurable EM-125 Parameters

Wi-Fi

Parameter	Range	Default Value
Network name (SSID)	32 ASCII characters	"NT_CHECK_P1"
Network password	64 ASCII characters	"12345678"
TCP/IP settings	Manual / Automatic	Automatic
IP address	0.0.0.0 – 255.255.255.255	192.168.0.2
Subnet mask	0.0.0.0 – 255.255.255.255	255.255.255.0
Default gateway	0.0.0.0 – 255.255.255.255	192.168.0.1

Voltage Protection

Parameter	Range	Default Value
Upper threshold, V	230 – 290	255
Upper threshold disconnect delay, s	0.2 – 2.0	0.5
Lower threshold, V	100 – 220	190
Lower threshold disconnect delay, s	0.2 – 60.0	12.0
Hysteresis, V	0 – 20	5
Reconnection delay, s	0.5 – 600.0	5.0
Number of reconnections	No, 1, 2, 3, 5, 7, 10, Always	Always

Current Protection

Parameter	Range	Default Value
Current threshold, A	1.0 – 16.0	10.0
Disconnect delay, s	0.2 – 10.0	5.0

Parameter	Range	Default Value
Reconnection delay, s	0.5 – 600.0	60.0
Number of reconnections	No, 1, 2, 3, 5, 7, 10, Always	3

Power Protection

Parameter	Range	Default Value
Protection enabled	Disabled / By active / By apparent	By active
Power threshold, W	100 – 3680	2300
Disconnect delay, s	0.2 – 10.0	5.0
Reconnection delay, s	0.5 – 600.0	60.0
Number of reconnections	No, 1, 2, 3, 5, 7, 10, Always	3

Vacation

Parameter	Range	Default Value
Enabled	Disabled / Enabled	Disabled
Start date	dd.mm.yyyy	17.08.2018
End date	dd.mm.yyyy	17.08.2018

Device Access

Parameter	Range	Default Value
Device name	32 ASCII characters	"EM-125"
Web access password	32 ASCII characters	"admin"

Electricity Cost

Parameter	Range	Default Value
Electricity cost	0.001 – 999.999	1.000
Currency	BYR, BGN, CZK, CHF, EUR, GBP, INR, KZT, LVL, LTL, MDL, PLN, PRB, RUB, RON, SEK, UAH, USD	EUR

Date and Time

Parameter	Range	Default Value
Time zone (GMT)	GMT-12:00 – GMT+13:00	GMT+0:00
Time correction, s	-9.9 – +9.9	+0.0
Auto daylight saving	No / Yes	No
Time synchronization	Disabled / Enabled	Enabled
NTP server address	32 ASCII characters	"time.windows.com"
Connection port	1 – 65535	123
Synchronization period, s	3600 – 86400	7200

my.overvis.com Cloud

Parameter	Range	Default Value
Enabled	Disabled / Enabled	Enabled
Server address	32 ASCII characters	"my.overvis.com"
Connection port	1 – 65535	20502

Advanced

Parameter	Range	Default Value
Device lock after, s	No, 60 – 43200	No
Button lock	No, 60 – 600	No
Reconnection counter reset time, s	60 – 3600	60
Indication brightness	1 – 15	12

Remote Configuration and Control via "my.overvis.com" Server

Configuration and control via the "my.overvis.com" server is only possible after configuring the Wi-Fi connection and completing authorization on the "my.overvis.com" server (see "Wi-Fi Connection Setup").

On an electronic device (PC, laptop, mobile phone, tablet, etc.), enter the link "<http://my.overvis.com/smartplug>" in the web browser address bar (Google Chrome, Opera, Firefox, etc.) and navigate to it.

The device screen will display connection options for EM-125. Select the most appropriate option and follow the further instructions displayed on the screen.

After connecting to EM-125, configure the necessary parameters by following the on-screen instructions.

To disconnect from EM-125 — simply close the "my.overvis.com" page.

7 Product Operation Description

The product operation description uses the manufacturer's default settings.

Note

All described thresholds and time delays can be changed by the user via the "my.overvis.com" server (described above).

Normal Product Operation

After connecting EM-125 to a mains socket, there is a 5-second delay, then, if the mains voltage is within acceptable limits, the product starts turning the load on/off according to the user-defined schedule.

Note

After the 5-second period expires, if no schedule is set (disabled), the load is automatically turned on.

After turning on the load, EM-125 constantly monitors the mains voltage, current, and power consumed by the load. If any of them exceeds the set thresholds, EM-125 performs emergency load disconnection.

Also, after plugging EM-125 into a mains socket, it connects to the user-designated Wi-Fi network (for time synchronization and access to the "my.overvis.com" server).

Every 5 minutes, EM-125 saves statistics (voltage, current, power values, etc.) to non-volatile memory for subsequent transmission to the "my.overvis.com" server.

After receiving a manual control command (from the front panel or the "my.overvis.com" server), the execution of the current scheduled event is blocked, the load is turned off (or on, depending on the command), and EM-125 switches to manual control mode.

After the next scheduled event occurs, manual control is disabled and EM-125 returns to normal operation mode.

Every 1-2 hours (depending on the "my.overvis.com" server load), accumulated statistics are sent to the "my.overvis.com" server.

Load Protection by Mains Voltage

During operation, EM-125 constantly measures the mains voltage.

In case of a sharp voltage increase above 300 ± 10 V, load disconnection occurs with a minimum delay of 0.02 s (fixed time).

In case of a gradual voltage increase above the 255 V threshold (upper disconnect threshold), the load will be disconnected after 0.5 s (upper threshold disconnect delay).

After disconnecting the load, if the mains voltage drops below 250 V ("Upper disconnect threshold" minus "Hysteresis"), return to normal operation mode will occur after the AR time.

In case of voltage drop below the 190 V threshold (lower disconnect threshold), the load will be disconnected after 12.0 seconds (lower threshold disconnect delay).

After disconnecting the load, if the mains voltage rises above 195 V ("Lower disconnect threshold" plus "Hysteresis"), return to normal operation mode will occur after the AR time.

Product operation in emergency mode is described in the "Load Disconnection Due to Emergency" section.

Load Protection by Consumption Current

During operation, EM-125 constantly measures the current consumed by the load.

In case of load current increase above the 10 A threshold (disconnect threshold), the load will be disconnected after 5.0 seconds (disconnect delay).

After disconnecting the load, return to normal operation mode will occur after the AR time.

Product operation in emergency mode is described in the "Load Disconnection Due to Emergency" section.

Load Protection by Consumption Power

During operation, EM-125 constantly measures the power consumed by the load.

In case of load power increase above the 2300 W threshold (disconnect threshold), the load will be disconnected after 5.0 seconds (disconnect delay).

After disconnecting the load, return to normal operation mode will occur after the AR time.

Product operation in emergency mode is described in the "Load Disconnection Due to Emergency" section.

Load Disconnection Due to Emergency

In case of an emergency situation (voltage, current, power exceeding values, etc.), the load is disconnected, the AR time countdown begins, and the "ENTER" button starts glowing red.

After the emergency situation disappears, the "ENTER" button starts flashing red with a 0.5 s period, indicating that the AR time countdown is in progress, after which the load will be automatically turned on.

If the AR time countdown ended before the emergency situation disappeared, then the load will be turned on without delay after the emergency situation disappears.

If the number of automatic reconnection attempts has been exceeded (for current and power protection — "3", for voltage protection — "no"), the product will block load activation and the "ENTER" button will glow red continuously.

To restore product operation, disconnect it from the mains socket, wait 5 seconds, and plug it back in.

Load Control from Front Panel

A single press of the "ENTER" button lasting 2-4 seconds switches the product to manual load control mode, where each button press turns on (if it was off) or turns off (if it was on) the load.

Note

As child protection, front panel control can be blocked in the EM-125 settings.

Factory Reset

To reset to factory settings:

- Unplug the product from the mains socket
- Disconnect the load from the product socket
- Press and hold the "ENTER" button on the product front panel
- Plug the product into the mains socket and continue holding the button for 3 seconds. The "ENTER" button will start flashing blue-red rapidly, release the "ENTER" button

After the factory reset is complete, the "ENTER" button will stop flashing, and the product will automatically restart.

Settings are reset to factory defaults and the product is ready for use.

Data Exchange Protocol Between EM-125 and "my.overvis.com" Server

The data exchange protocol between EM-125 and the "my.overvis.com" server is a closed protocol and is not disclosed for security reasons.

All data is received and sent in encrypted form using 256-bit encryption.

8 Operating Conditions

The product is designed for operation under the following conditions:

- Ambient temperature from -5 to +40 °C
- Atmospheric pressure from 84 to 106.7 kPa
- Relative humidity (at +25 °C) 30 ... 80%

Note

Before connecting to the electrical network, keep the product in operating conditions for two hours (as moisture condensation may occur on the product elements).

ATTENTION!

The product is not designed for operation under conditions of:

- Significant vibration and shock
- High humidity
- Aggressive environment with acids, alkalis, etc. in the air, as well as heavy contamination (grease, oils, dust, etc.)

9 Safety Measures

STRICTLY PROHIBITED:

- Opening and repairing the product independently
- Operating the product with mechanical damage to the housing

Do not allow water to get on the internal elements of the product, socket, and plug.

To improve operational characteristics, it is recommended to use the product at a load current not exceeding 10 A.

During operation and maintenance, follow the requirements of: "Rules for Technical Operation of Consumer Electrical Installations"; "Safety Rules for Operation of Consumer Electrical Installations"; "Occupational Safety in Operation of Electrical Installations".

10 Maintenance

During maintenance, disconnect the product and devices connected to it from the mains socket.

Recommended maintenance frequency — every six months.

Maintenance procedure:

1. Visually check for carbon deposits on the product plug; if found, remove the carbon deposits
2. Visually check the housing integrity; if cracks and chips are found, remove the product from service and send it for repair
3. If necessary, wipe the product housing with a cloth

Note

Do not use abrasive materials and solvents for cleaning.

11 Transportation and Storage

The product in the manufacturer's packaging can be transported and stored at temperatures from -45 to +60 °C and relative humidity not more than 80%. During transportation, the product should be protected from mechanical damage.

12 Service Life and Manufacturer's Warranty

Product service life is 10 years. After the service life expires, contact the manufacturer.

Storage period — 3 years.

The warranty period for product operation is 3 years from the date of sale.

During the warranty period of operation (in case of product failure), the manufacturer performs free product repair.

Caution

IF THE PRODUCT WAS OPERATED IN VIOLATION OF THE REQUIREMENTS OF THIS OPERATING MANUAL, THE BUYER LOSES THE RIGHT TO WARRANTY SERVICE.

Warranty service is provided at the place of purchase or by the product manufacturer. Post-warranty service of the product is performed by the manufacturer at current rates.

Before sending for repair, the product must be packed in factory or other packaging that prevents mechanical damage.

For all inquiries, contact the manufacturer:

NOVATEK-ELECTRO LTD

59, Mykhaila Boltenka (Adm. Lazareva) St.

Odesa, 65007, Ukraine

tel. +38 (067) 565 37 68

+38 (067) 557 12 49

www.novatek-electro.com

VN250820